

POWER TOOL ACCESSORIES



MORSE[®]
THE M. K. MORSE COMPANY

MORSE[®]

THE M. K. MORSE COMPANY

M. K. Morse products are manufactured in Canton, Ohio, in one of the industry's most advanced production facilities. This facility has undergone a number of expansions over the years as we developed our unique integrated manufacturing approach that helps us ship most orders for standard stock products within 24 hours.

In addition to this plant, there are M. K. Morse warehouses in California, Canada, England, Finland and India. Our products are available to professional contractors through a worldwide network of professional contractor and industrial supply distributors. To find your nearest M. K. Morse distributor call 1-800-733-3377. Internationally call 001-330-453-8187.



RAPID RESPONSE
QUESTIONS? CALL FOR SOLUTIONS
800-733-3377 ▼ 330-453-8187



WE HELP **POWER TOOLS** DO THEIR JOB BETTER

Our whole business is making saw blades for professionals. We make blades that last longer, cut smoother and do every conceivable cutting job. We make them for plumbers, electricians, carpenters, roofers, sheet metal workers, and anyone who uses power tools.

We make it our job to never, ever, let these people down. Toward this end we've continually invested in better research and development, better manufacturing processes, better raw materials and better warehousing facilities. The result is a wide-ranging product line that offers professionals blades that work better and last longer.

THE SAW MAKERS ART AS PRACTICED AT M. K. MORSE

Since 1963 we have been developing, improving and refining our saw blade manufacturing processes. The saw makers' art, as practiced by Morse, is a combination of state-of-the-art production facilities, engineering innovation and personal skill.

Many of our engineering and production employees have been at it for decades. Today they work in a fully integrated manufacturing facility where we do everything but make our own steel. This gives us total control of our processes, making it easier for us to meet tight production deadlines.

For more information about The M. K. Morse Company, these products or our complete line of band saw products...

visit us at mkmorse.com

Table of Contents

Hole Cutting & Boring Tools

Advanced Edge Premium Hole Saws	5	
Master Cobalt® Bi-Metal Hole Saws	7	
Master Cobalt® Deep Cut Hole Saws	8	
Carbide Tipped Hole Saws	8	
Tungsten Carbide Grit Hole Saws	9	
Recessed Lighting Hole Saws	9	
Master Cobalt® Hole Saw Kits	10	
Arbors and Accessories	12	
The Real McCoy® Bi-Metal Hole Saws	13	
The Real McCoy® Hole Saw Kits	14	
Combination Hole Saw Kits	15	
Spade Bits & Step Drills (HSS & TiN)	16	
Double Cut Auger Bits	17	
Self Feeding Wood Bits	17	

Reciprocating Saw Blades

Master Cobalt® Bi-Metal Blades	18
Morse Bi-Metal Blades	19
The Real McRipper® Demolition Blades	21
Fire & Rescue Blades	21
U-Shank Blades	21
Bi-Metal Reciprocating Blade Kits	21
Jab Saw	22
Tungsten Carbide Grit/Tipped Blades	22
Air Saw Bi-Metal Blades	22

Jig Saw Blades

Morse Bi-Metal Jig Saw Blades	24
Carbon Jig Saw Blades	25
Bayonet Shank Blades	26
Carbide Grit Blades	26

Portable Band Saw Blades

Master Cobalt® Bi-Metal Blades	28
Morse Standard Bi-Metal Blades	28
Carbon Blades	29
Stationary Band Saw Blades	29

Metal Cutting Circular Saw Blades

Morse Metal Devil NXT™ Information	31	
Morse Metal Devil® & Metal Devil NXT™	32	

Metal Cutting Circular Saw Machines

Morse Metal Devil® Circular Saws	33
Morse Metal Devil® V-Blocks	34
Type 1 Abrasive Wheel Mandrels	34

Hack Saw Blades and Frames

Bi-Metal Triple Tooth™ Blades	36
Bi-Metal Blades	36
Carbide Grit Hack Saw Blades	37
Hack Saw Frames	37/38
PVC/ABS Hand Saw & Blades	39
Power Hack Saw Blades	39

Information

M. K. Morse Warranty	Back Cover
Mailing & Shipping Addresses	Back Cover





HOLE SAWS

Morse Hole Saws now utilize the latest technology, which has taken these hole saws to the very top of the charts in cutting performance and long life. Hole Saws from The M. K. Morse Company are uniquely designed to clear chips during cutting so they require less cutting pressure and last longer. When it comes to making holes in any material, Morse leads the way.

Advanced Edge Bi-Metal	Master Cobalt® Bi-Metal AV	Master Cobalt® Bi-Metal AD	Tungsten Carbide Tipped	Tungsten Carbide Grit	Real McCoy® TA Style	Spade Bits	Step Drills
Blade Type			Application				
Advanced Edge Premium Bi-Metal Hole Saws			Engineered for optimized cutting performance and life. Exceptional durability yields cost-per-cut savings over other saws when cutting stainless steel, steel, machinable metals, nail-embedded woods & plastics.				
Master Cobalt® Bi-Metal AV Hole Saws			All types of machinable metal including stainless steel, wood, nail-embedded wood, plastic. Standard 1-1/2" cutting depth cuts through 2 x 4's. Requires a separate arbor for operation.				
Master Cobalt® Bi-Metal Deep Cutting AD Hole Saws			Same cutting applications as Master Cobalt® AV style, but the AD style is deep cutting with a 1-7/8" cutting depth. Also requires a separate arbor.				
Tungsten Carbide Tipped AT Hole Saws			Nail free wood, plastic, fiberglass, drywall, fiberboard, plaster, acoustic tile, countertops. Coarser tooth pitch than bimetal hole saws for very fast cutting in soft material. Not recommended for pipe. Standard 1-1/2" cutting depth. Requires separate arbor.				
Tungsten Carbide Grit Edge ATCG Hole Saws			For use in very hard or abrasive material. Hardened steel, cast iron, brick, cinder block, ceramics, formed glass, fiberglass, composites, computer flooring, cement, acoustic tile. Standard 1-1/2" cutting depth. Requires separate arbor.				
Real McCoy® Bi-Metal TA Hole Saws w/ Built-In Arbor			All types of machinable metal including stainless steel, wood, nail-embedded wood, plastic. Standard 1-1/2" cutting depth cuts through 2 x 4's. Pass through shank – no separate arbor required.				
Spade Bits			Wood, plastic, plywood, formica. Fast, deep cutting at any angle.				
Step Drills			Sheet metal, plastic/plexiglass, PVC, composition board, plasterboard. Use to drill new holes or enlarge existing holes. Also use to deburr in auto rust proofing.				

NEW
FROM THE M. K. MORSE COMPANY

advanced edge

THE INDUSTRY'S
HARDEST
WORKING
BI-METAL HOLE SAW



Unique Tooth Face Design & Aggressive Tooth Rake Angle

Advantage: Smooth efficient chip clearing in a wide range of cutting applications.

Benefit: Maximum penetration into work piece for quick efficient cutting.

Larger Tooth Profile

Advantage: Increased impact resistance in interrupted cuts.

Benefit: Longer tooth life while maintaining cutting penetration.

Deeper Gullets

Advantage: Smooth chip clearing in "deep" cutting applications.

Benefit: Efficient chip clearing provides longer tooth life.

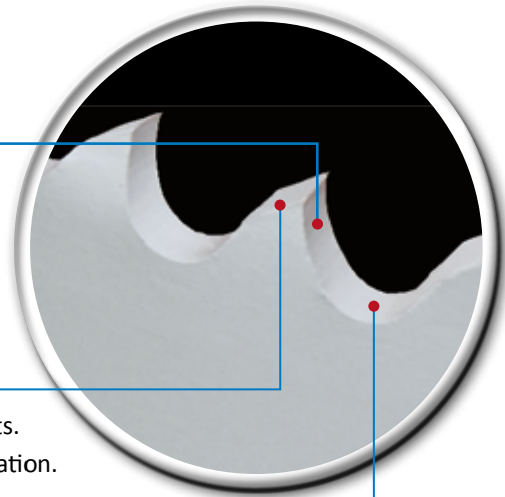

PTP Set Technology

Advantage:

- More teeth to share the cutting load.
- All teeth are perpendicular to work surface.
- Cutting forces are evenly distributed.

Benefit:

- Smoother cutting
- Increased cutting life

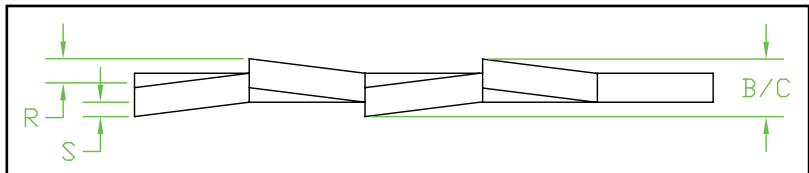

Hole Saw Kits

Description	Product #	Diameter													Arbors		
		3/4"	7/8"	1-1/8"	1-3/8"	1-1/2"	1-3/4"	2"	2-1/4"	2-1/2"	3"	3-5/8"	4-1/8"	4-3/4"			
Electricians Kit	8 piece	MK0600L		▼	▼	▼		▼	▼		▼						MK05, MK03
Plumbers Kit	8 piece	MK8600P	▼	▼	▼		▼	▼		▼							MK05, MK03
General Purpose Kit	11 piece	MK7700G	▼	▼	▼	▼	▼	▼	▼	▼	▼						MK05, MK03
Master Electricians Kit	14 piece	MK21200L	▼	▼	▼	▼		▼	▼		▼	▼	▼	▼	▼	▼	MK05, MK03 MK04

Arbors

PACKAGING: 1 per box

Product #	Shank Size	Use with diameters:
MK03	7/16"	Over 1-1/4"
MK04	1/4"	Up to 1-3/16"
MK05	3/8"	Up to 1-3/16"
MK06	3/8"	Over 1-1/4"



Pilot Drills

PACKAGING: 10 per pack

Product #	Description
MK5156PD	3-1/16" x 1/4" (78mm x 6.5mm)

PACKAGING: 1 per box, 2 boxes per standard pack

Diameter*		Product Numbers		Pipe Tap Size Inches	Pipe Ent. Size Inches	Diameter*		Product Numbers		Pipe Tap Size Inches	Pipe Ent. Size Inches
Inches	mm	Prod. #	Comp. #			Inches	mm	Prod. #	Comp. #		
MK09-MK244 use the following 1/2-20 arbors MK04 or MK05						MK20-MK38 use the following 5/8-18 arbors MK03, MK06					
9/16	14	MK09	168304			2-1/16	52	MK33	168656		
5/8	16	MK10	168311			2-1/8	54	MK34	168663		
	16	MK105	168328				55	MK345	168670		
11/16	17	MK11	168335			2-1/4	57	MK36	168687	2	
3/4	19	MK12	168342	1/2	3/8	2-5/16	59	MK37	168694		
	20	MK125	168359			2-3/8	60	MK38	168700		
13/16	21	MK13	168366				62	MK385	168717		
7/8	22	MK14	168373	3/4	1/2	MK40-MK96 use the following 5/8-18 arbors MK03, MK06					
15/16	24	MK15	168380			2-1/2	64	MK40	168724		2
	25	MK155	168397			2-9/16	65	MK41	168731		
1	25	MK16	168403			2-5/8	67	MK42	168748	2-1/2	
1-1/16	27	MK17	168410				68	MK425	168755		
1-1/8	29	MK18	168427	1	3/4	2-11/16	68.5	MK435	168762		
	30	MK185	168434			2-3/4	70	MK44	168779		
1-3/16	30	MK19	168441			2-7/8	73	MK46	168786		
1-1/4	32	MK204	168465				75	MK475	168793		
1-3/8	35	MK224	168502			3	76	MK48	168809		2-1/2
1-1/2	38	MK244	168540	1-1/4		3-1/8	79	MK50	168816		
MK20-MK385 use the following 5/8-18 arbors MK03, MK06						3-1/4	83	MK52	168823	3	
1-1/4	32	MK20	168458			3-3/8	86	MK54	168830		
	32	MK205	168472			3-1/2	89	MK56	168847		
1-5/16	33	MK21	168489			3-5/8	92	MK58	168854		3
1-3/8	35	MK22	168496		1	3-3/4	95	MK60	168861	3-1/2	
	35	MK225	168519			3-7/8	98	MK62	168878		
1-7/16	37	MK23	168526				100	MK63	168885		
1-1/2	38	MK24	168533	1-1/4		4	102	MK64	168892		
1-9/16	40	MK25	168557			4-1/8	105	MK66	168908		3-1/2
	40	MK255	168564			4-1/4	108	MK68	168915	4	
1-5/8	41	MK26	168571			4-3/8	111	MK70	168922		
1-11/16	43	MK27	168588			4-1/2	114	MK72	168939		4
1-3/4	44	MK28	168595	1-1/2	1-1/4	4-3/4	121	MK76	168946	4-1/2	
	45	MK285	168601			5	127	MK80	168953		
1-13/16	46	MK29	168618			5-1/4	133	MK84	168960		
1-7/8	48	MK30	168625			5-1/2	140	MK88	168977		
	50	MK315	168632			5-3/4	146	MK92	168984		
2	51	MK32	168649		1-1/2	6	152	MK96	168991		

* Metric sizes shown in red are exact millimeter sizes. Metric sizes in black are approximate metric equivalents of exact inch sizes

MASTER COBALT® BI-METAL HOLE SAWS

This premium line of professional quality hole saws features an M3 high-speed steel cutting edge, electron beam welded to a tough steel backer. Caps stand up to abuse and punishment, yet are lighter and easier to use than those of competitors. Positive rake tooth design provides better chip clearance as teeth cut into wood, plastic or any machinable metal. The 1-1/2" cutting depth cuts easily through 2x4's. A separate arbor is required (see page 12).

Backer, cutting edge and cap work together to provide faster, longer-lasting cutting action

Bi-metal design bonds M3 cutting edge to fatigue resistant backer



Positive rake teeth clear chips better for longer life and easier cutting

Teeth stay sharper and make smoother cuts

PACKAGING: 1 per box
1 per card, 2 cards per standard pack

Diameter*		Product Number				Pipe Tap Size Inches	Pipe Ent. Size Inches
Inches	mm	Boxed Prod. #	Boxed Comp #	Carded Prod. #	Carded Comp #		
AV09-AV244 use the following 1/2-20 arbors M24, M24K, M34, M44, or M44K							
9/16	14	AV09	170093	AVC09	130097		
5/8	16	AV10	170109	AVC10	130103		
	16	AV105	175104	AVC105	130646		
11/16	17	AV11	170116	AVC11	130110		
	17	AV11	170116	AVC11	130110		
3/4	19	AV12	170123	AVC12	130127	1/2	3/8
	20	AV125	175128	AVC125	135122		
13/16	21	AV13	170130	AVC13	130134		
	21	AV13	170130	AVC13	130134		
7/8	22	AV14	170147	AVC14	130141	3/4	1/2
	24	AV15	170154	AVC15	130158		
15/16	25	AV155	175159	AVC155	135153		
	25	AV155	175159	AVC155	135153		
1	25	AV16	170161	AVC16	130165		
1-1/16	27	AV17	170178	AVC17	130172		
1-1/8	29	AV18	170185	AVC18	130189	1	3/4
	30	AV185	175180	AVC185	135184		
1-3/16	30	AV19	170192	AVC19	130196		
1-1/4	32	AV204	174022	AVC204	134200		
1-3/8	35	AV224	174220	AVC224	134224		
	38	AV244	174244	AVC244	134248	1-1/4	
AV20-AV385 use the following 5/8-18 arbors M35PS, M45, M45P, M46PS, M55P, or M44K							
1-1/4	32	AV20	170208	AVC20	130202		
	32	AV205	175203	AVC205	135207		
1-5/16	33	AV21	170215	AVC21	130219		
1-3/8	35	AV22	170222	AVC22	130226		1
	35	AV225	175227	AVC225	135221		
1-7/16	37	AV23	170239	AVC23	130233		
1-1/2	38	AV24	170246	AVC24	130240	1-1/4	
1-9/16	40	AV25	170253	AVC25	130257		
	40	AV255	175258	AVC255	135252		
1-5/8	41	AV26	170260	AVC26	130264		
1-11/16	43	AV27	170277	AVC27	130271		
1-3/4	44	AV28	170284	AVC28	130288	1-1/2	1-1/4
	45	AV285	175289	AVC285	135283		
1-13/16	46	AV29	170291	AVC29	130295		
1-7/8	48	AV30	170307	AVC30	130301		
	50	AV315	175319	AVC315	135313		
2	51	AV32	170321	AVC32	130325		1-1/2

Diameter*		Product Number				Pipe Tap Size Inches	Pipe Ent. Size Inches
Inches	mm	Boxed Prod. #	Boxed Comp #	Carded Prod. #	Carded Comp #		
AV20-AV38 use the following 5/8-18 arbors M35PS, M45, M45P, M46PS, M55P, or M44K							
2-1/16	52	AV33	170338	AVC33	130332		
	54	AV34	170345	AVC34	130349		
2-1/8	55	AV345	175340	AVC345	135344		
	57	AV36	170369	AVC36	130363	2	
2-5/16	59	AV37	170376	AVC37	130370		
2-3/8	60	AV38	170383	AVC38	130387		
	62	AV385	175388				
AV40-AV96 use the following 5/8-18 arbors M45P, M46PS, M55P, or M44K							
2-1/2	64	AV40	170406	AVC40	130400		2
2-9/16	65	AV41	170413	AVC41	130417		
2-5/8	67	AV42	170420	AVC42	130424	2-1/2	
	68	AV425	175425	AVC425	135429		
2-11/16	68.5	AV435	175432	AVC435	135436		
2-3/4	70	AV44	170444	AVC44	130448		
2-7/8	73	AV46	170468	AVC46	130462		
	75	AV475	175470	AVC475	135474		
3	76	AV48	170482	AVC48	130486		2-1/2
3-1/8	79	AV50	170505	AVC50	130509		
3-1/4	83	AV52	170529	AVC52	130523	3	
	86	AV54	170543	AVC54	130547		
3-1/2	89	AV56	170567	AVC56	130561		
3-5/8	92	AV58	170581	AVC58	130585		3
	95	AV60	170604	AVC60	130608	3-1/2	
3-3/4	98	AV62	170628	AVC62	130622		
	100	AV63	170635	AVC63	130639		
4	102	AV64	170642	AVC64	130646		
4-1/8	105	AV66	170666	AVC66	130660		3-1/2
4-1/4	108	AV68	170680	AVC68	130684	4	
4-3/8	111	AV70	170703	AVC70	130707		
4-1/2	114	AV72	170727	AVC72	130721		4
4-3/4	121	AV76	170765	AVC76	130769	4-1/2	
5	127	AV80	170802	AVC80	130806		
5-1/4	133	AV84	170840				
5-1/2	140	AV88	170888	AVC88	130882		
5-3/4	146	AV92	170925	AVC92	130929		
	152	AV96	170963	AVC96	130967		

* Metric sizes shown in red are exact millimeter sizes. Metric sizes in black are approximate metric equivalents of exact inch sizes.
For Master Cobalt® Hole Saw Kits see pages 8 & 9. For arbors and accessories, see page 12.



BULK PACK HOLE SAWS - 25 per box							
Same spec. No individual boxes. Packed in a flat divided box.							
Inches	mm	Prod. #	Comp #	Inches	mm	Prod. #	Comp #
3/4	19	AV12B25	169004	1-1/2	38	AV24B25	169059
7/8	22	AV14B25	169011	1-5/8	41	AV26B25	169066
1	25	AV16B25	169028	1-7/8	48	AV30B25	169073
1-1/8	29	AV18B25	169035	2	51	AV32B25	169080
1-1/4	32	AV20B25	169042	2-1/8	54	AV34B25	169097
1-3/8	35	AV22B25	169349	2-3/8	60	AV38B25	169103

MASTER PACK HOLE SAWS - 20 per box							
Same spec. Individually boxed. Can be a shelf or counter POP.							
Inches	mm	Prod. #	Comp #	Inches	mm	Prod. #	Comp #
3/4	19	AV12M20	169110	1-1/2	38	AV24M20	169165
7/8	22	AV14M20	169127	1-5/8	41	AV26M20	169172
1	25	AV16M20	169134	1-7/8	48	AV30M20	169189
1-1/8	29	AV18M20	169141	2	51	AV32M20	169196
1-1/4	32	AV20M20	169158				

MASTER COBALT® DEEP CUTTING BI-METAL HOLE SAWS

1-7/8" cutting depth provides extra depth for specialty cuts made by locksmiths, remodelers and general contractors alike. Easily cuts through 2 x 4's, joists and most doors in one pass with extra clearance.

PACKAGING: 1 per box

Variable pitch smooths cutting action with minimum vibration

M3 cutting edge for high wear resistance and longer life



Diameter		Product #	Computer #	Pipe Tap Size Inches	Pipe Ent. Size Inches	Diameter		Product #	Computer #	Pipe Tap Size Inches	Pipe Ent. Size Inches
Inches	mm					Inches	mm				
3/4	19	AD12	150002	1/2	3/8	2-3/4	70	AD44	150354		
7/8	22	AD14	150019	3/4	1/2	3	76	AD48	150132		2-1/2
1	25	AD16	150026			3-1/4	83	AD52	150385	3	
1-1/8	29	AD18	150033	1	3/4	3-3/8	86	AD54	150149		
1-3/16	30	AD19	150248			3-1/2	89	AD56	150187		
1-1/4	32	AD20	150040			3-3/4	95	AD60	150408		
1-3/8	35	AD22	150057		1	3-7/8	98	AD62	150194	3-1/2	
1-1/2	38	AD24	150064	1-1/4		4	102	AD64	150200		
1-3/4	44	AD28	150071	1-1/2	1-1/4	4-1/4	108	AD68	150156		
1-7/8	48	AD30	150088		1-1/2	4-1/2	114	AD72	150439		4
2	51	AD32	150095			4-3/4	121	AD76	150446	4-1/2	
2-1/8	54	AD34	150101			5	127	AD80	150453		
2-1/4	57	AD36	150118	2		5-1/2	140	AD88	150460		
2-3/8	60	AD38	150170			6	152	AD96	150484		
2-1/2	64	AD40	150125		2	6-5/8	168	AD106	150163		

CARBIDE TIPPED MAINTENANCE KIT: AT100 / 160056

Contains popular sizes used in installation of 1/2"-2" pipe and conduit through abrasive materials. Saws (1 each): 3/4", 7/8", 1-1/8", 1-3/8", 1-1/2", 1-3/4", 2", 2-1/4", 2-1/2" Arbors (1 each): M24K, M44, M45P Extension (1): 12"



CARBIDE TIPPED ELECTRICIANS KIT: AT02E / 160001

Pipe and conduit entrance sizes to 2" through abrasive materials. Saws (1 each): 7/8", 1-1/8", 1-3/8", 1-3/4", 2", 2-1/2" Arbors (1 each): M34CT, M45PCT



CARBIDE TIPPED HOLE SAWS

Specifically designed for sawing holes in abrasive materials such as fiberglass, particleboard, cement board, asbestos board, and formica.

PACKAGING: 1 per box

Diameter		Product #	Comp #	Diameter		Product #	Comp #
Inches	mm			Inches	mm		
11/16	16	AT105	160100	2-3/8	60	AT38	160384
3/4	19	AT11	160117	2-1/2	64	AT40	160407
13/16	21	AT12	160124	2-9/16	65	AT41	160414
7/8	22	AT13	160131	2-5/8	67	AT42	160421
15/16	24	AT14	160148	2-11/16	68	AT43	160438
1	25	AT15	160155	2-3/4	70	AT44	160445
1-1/16	27	AT16	160162	2-7/8	73	AT46	160469
1-1/8	29	AT17	160179	3	76	AT48	160483
1-3/16	30	AT18	160186	3-1/8	79	AT50	160506
1-1/4	32	AT19	160193	3-1/4	83	AT52	160520
1-5/16	33	AT20	160209	3-3/8	86	AT54	160544
1-3/8	35	AT21	160216	3-1/2	89	AT56	160568
1-7/16	37	AT22	160223	3-5/8	92	AT58	160582
1-1/2	38	AT23	160230	3-3/4	95	AT60	160605
1-9/16	40	AT24	160247	3-7/8	98	AT62	160629
1-5/8	41	AT25	160254	4	102	AT64	160643
1-11/16	43	AT26	160261	4-1/8	105	AT66	160667
1-3/4	44	AT27	160278	4-1/4	108	AT68	160681
1-13/16	46	AT28	160285	4-3/8	111	AT70	160704
1-7/8	48	AT29	160292	4-1/2	114	AT72	160728
2	51	AT30	160308	4-3/4	121	AT76	160766
2-1/16	52	AT32	160322	5	127	AT80	160803
2-1/8	54	AT33	160339	5-1/4	133	AT84	160841
2-1/4	57	AT34	160346	5-1/2	140	AT88	160889
2-5/16	59	AT36	160360	5-3/4	146	AT92	160926
		AT37	160377	6	152	AT96	160964

For arbors and accessories, see page 12.

Tungsten carbide tooth tips offer the highest wear resistance possible and longer life cutting abrasive materials



Ground and set teeth to help cut materials that bi-metal saws will not cut



Teeth create wider gullet for better chip clearance and faster cutting

TUNGSTEN CARBIDE GRIT HOLE SAWS

The long-lasting choice for cutting holes in materials too hard or abrasive for standard bi-metal saws, or so thin they would strip bi-metal or chip carbide teeth. Ideal for cutting ceramics, fiberglass, hardwoods, cast iron, composites, etc.



Super resistance to heat, wear and abrasion with shock resistant back

Tungsten carbide grains are bonded to alloy backs with a gulleted, snag resistant edge

1-1/2" cutting depth.

PACKAGING: 1 per box

Diameter		Product #	Comp #	Pipe Tap Size Inches	Pipe Ent. Size Inches	Diameter		Product #	Comp #	Pipe Tap Size Inches	Pipe Ent. Size Inches
Inches	mm					Inches	mm				
3/4	19	ATCG12	161084	1/2	3/8	2-3/8	60	ATCG38	161299		
13/16	21	ATCG13	161091			2-1/2	64	ATCG40	161305		2
7/8	22	ATCG14	161107	3/4	1/2	2-9/16	65	ATCG41	161312		
15/16	24	ATCG15	161114			2-5/8	67	ATCG42	161329	2-1/2	
1	25	ATCG16	161121			2-3/4	70	ATCG44	161336		
1-1/16	27	ATCG17	161138			2-7/8	73	ATCG46	161343		
1-1/8	29	ATCG18	161145	1	3/4	3	76	ATCG48	161350		2-1/2
1-3/16	30	ATCG19	161152			3-1/8	79	ATCG50	161367		
1-1/4	32	ATCG20	161008			3-1/4	83	ATCG52	161374	3	
1-5/16	33	ATCG21	161169			3-3/8	86	ATCG54	161381		
1-3/8	35	ATCG22	161015		1	3-1/2	89	ATCG56	161398		
1-7/16	37	ATCG23	161176			3-5/8	92	ATCG58	161077		3
1-1/2	38	ATCG24	161183	1-1/4		3-3/4	95	ATCG60	161404	3-1/2	
1-9/16	40	ATCG25	161190			3-7/8	98	ATCG62	161411		
1-5/8	41	ATCG26	161206			4	102	ATCG64	161428		
1-11/16	43	ATCG27	161213			4-1/8	105	ATCG66	161435		3-1/2
1-3/4	44	ATCG28	161022	1-1/2	1-1/4	4-1/4	108	ATCG68	161442	4	
1-13/16	46	ATCG29	161220			4-3/8	111	ATCG70	161039		
1-7/8	48	ATCG30	161237			4-1/2	114	ATCG72	161459		4
2	51	ATCG32	161244		1-1/2	4-3/4	121	ATCG76	161466	4-1/2	
2-1/16	52	ATCG33	161251			5	127	ATCG80	161473		
2-1/8	54	ATCG34	161268			5-1/2	140	ATCG88	161480		
2-1/4	57	ATCG36	161275	2		5-3/4	146	ATCG92	161497		
2-5/16	59	ATCG37	161282			6	152	ATCG96	161503		



TUNGSTEN CARBIDE GRIT HOLE SAW KIT: ATCG100 / 160995

Maintenance kit includes popular sizes for plumbing, electrical, and industrial maintenance jobs.

Saws (1 each): 3/4", 7/8", 1-1/8", 1-3/8", 1-1/2", 1-3/4", 2", 2-1/4", 2-1/2"

Arbors (1 each): M24KCT, M44CT, M45PCT

Extension (1): 12"

RECESSED LIGHTING HOLE SAW

Tungsten carbide grit hole saws are ideal for quick, easy installation of recessed lighting fixtures. They cut abrasive materials such as lath, plaster and ceiling tile.

PACKAGING: 1 per box

Diameter		Product #	Computer #	For Installing These Lighting Fixtures
Inches	mm			
4-3/8	111	ATCG70	161039	Mini Juno, Capri, Marco, Halo
6-3/8	162	ATCG104	161046	Halo, Capri
6-5/8	168	ATCG106	161053	Juno, Progress
6-7/8	174	ATCG110	161060	Lithonla, Marco, Lightolier, Progress, Capri, Preacolite
BIMETAL HOLE SAWS				
6-3/8	162	AV104	170314	Halo, Capri
6-5/8	168	AD106	150163	Juno, Progress



MASTER COBALT® BI-METAL HOLE SAW KITS

Special jobs need special tools. These handy kits keep the saw blade sizes pros need within easy reach. For comparable metric sizes see chart on page 11.



MASTER ELECTRICIANS KIT: AV08E / 171083

Entrance sizes to 4" Saws (1 each): 7/8", 1-1/8", 1-3/8", 1-3/4", 2", 2-1/2", 3" 3-5/8", 4-1/8", 4-1/2"
Arbors (1 each): M24K, M44, M45P



ELECTRICIANS KIT: AV02E / 171021

Entrance sizes to 2" Saws (1 each): 7/8", 1-1/8", 1-3/8", 1-3/4", 2", 2-1/2" Arbors (1 each): M44, M45P

SPECIAL ELECTRICIANS KIT: AV09E / 171090

2-1/2", 3", 3-1/2", 4" pipe entrance sizes. Saws (1 each): 3", 3-5/8", 4-1/8", 4-1/2" Arbors (1): M45P



ELECTRICIANS KIT: AV04E / 169431

Pipe and conduit entrance sizes through 2". Saws (1 each): 7/8", 1-1/8", 1-3/8", 1-3/4", 2", 2-1/2"
Arbors (1 each): M34, M45P Adaptor Nut (1): M44NH01

PLUMBERS KIT: AV04P / 171045

Contains pipe tap sizes for pipe through 2" Saws (1 each): 3/4", 7/8", 1-1/8", 1-1/2", 1-3/4", 2-1/4" Arbors (1 each): M44, M45P

MASTER PLUMBERS KIT: AV16P / 169417

Entrance sizes to 4" Saws (1 each): 3/4", 7/8", 1-1/8", 1-1/2", 1-3/4", 2-1/4", 2-9/16", 3", 3-1/2", 4, 4-1/4", 4-1/2" Arbors (1 each): M34, M45P
Pilot Drills (1 each): MPD4501, MPD401



MECHANICS KIT: AV05M / 171052

The 5 most popular hole saw sizes for construction, industrial and automotive jobs. Saws (1 each): 7/8", 1", 1-1/8", 1-1/4", 1-1/2" Arbor (1): M34



REFRIGERATION KIT: AV01R / 170994

Entrance sizes to 1-1/2" Saws (1 each): 5/8", 7/8", 1-1/8", 1-3/8", 1-5/8", 2-1/8" Arbor (1 each): M34, M35PS

MAINTENANCE KIT: AV100 / 171106

A handy general purpose kit for plumbing and electrical jobs on pipe and conduit through 2". Saws (1 each): 3/4", 7/8", 1-1/8", 1-3/8", 1-1/2", 1-3/4", 2", 2-1/4", 2-1/2" Arbors (1 each): M24K, M44, M45P Extension (1): 12"



UTILITY KIT: AV03U / 171076

6 commonly used hole saws for general purpose use. Saws (1 each): 3/4", 7/8", 1-1/8", 1-1/2", 1-3/4", 2-1/2"
Arbor (1): M34, M45P



LOCKSMITH KIT: AV02L / 171038

Designed for the professional locksmith, this kit contains sizes for installation of popular locks, deadbolts, etc.
Saws (1 each): 7/8", 1", 1-1/4", 1-1/2", 1-3/4", 2-1/8"
Arbors (1 each): M24, M45P



LOCKSMITH KIT: AV04L / 169448

A variation on our professional locksmith kit. Contains sizes for installation of popular locks, deadbolts, etc.
Saws (1 each): 7/8", 1", 1-1/4", 1-1/2", 1-3/4", 2-1/8"
Arbors (1 each): M34, M35PS



INDUSTRIAL KIT: AV08I / 169424

Covers a range of common industrial plumbing and electrical applications. Saws (1 each): 3/4", 7/8", 1", 1-1/4", 1-3/8", 1-1/2", 1-3/4", 2", 2-1/4", 2-1/2", 3" Arbors (1 each): M34, M45P
Extension (1): 12", Ejector Spring (1): MES101



INDUSTRIAL KIT: AV06I / 171069

Cover a broad range of common industrial plumbing and electrical jobs on pipe and conduit through 4".
Saws (1 each): 3/4", 7/8", 1", 1-1/8", 1-3/8", 1-1/2", 1-3/4", 2", 2-1/4", 2-1/2", 3", 3-1/4", 3-5/8", 3-3/4", 4-1/4", 4-1/2"
Arbors (1 each): M24K, M44, M45P Extension (1): 12"

MASTER TRADESMAN KIT: AV23M / 169356

Cover a broad range of common industrial maintenance, plumbing and electrical jobs on pipe and conduit through 4-1/2".
Saws (1 each): 3/4", 7/8", 1", 1-1/8", 1-3/8", 1-1/2", 1-3/4", 2", 2-1/8", 2-1/4", 2-1/2", 2-11/16", 3", 3-1/4", 3-3/8", 3-5/8", 3-3/4", 4-1/8", 4-1/2", 4-3/4"
Arbors (1 each): M34, M45P
Pilot Drills (1 each): MPD4S01, MPD401
Extension (1): 12"

KIT CONTENT COMPARISON CHART FOR AV HOLE SAW KITS

Diameter		AV08E	AV02E	AV09E	AV04E	AV04P	AV16P	AV05M	AV01R	AV100	AV03U	AV02L	AV04L	AV08I	AV06I	AV23M
Inches	mm															
5/8	16							X								
3/4	19				X	X			X	X			X	X	X	X
7/8	22	X	X		X	X	X	X	X	X	X	X	X	X	X	X
1	25						X		X		X	X	X		X	X
1-1/8	29	X	X		X	X	X	X	X	X				X	X	X
1-1/4	32						X				X	X	X			
1-3/8	35	X	X		X			X	X				X	X	X	X
1-1/2	38					X	X	X	X	X	X	X	X	X	X	X
1-5/8	41							X								
1-3/4	44	X	X		X	X			X	X	X	X	X	X	X	X
2	51	X	X		X				X				X	X	X	X
2-1/8	54							X			X	X				X
2-1/4	57				X	X			X				X	X	X	X
2-1/2	64	X	X		X				X	X			X	X	X	X
2-9/16	65					X										
2-11/16	68						X									X
3	76	X		X		X							X	X	X	X
3-1/4	83													X	X	X
3-3/8	86															X
3-1/2	89					X										
3-5/8	92	X		X										X	X	
3-3/4	95													X	X	
4	102					X										
4-1/8	105	X		X												X
4-1/4	108					X								X		
4-1/2	114	X		X		X								X	X	
4-3/4	121													X	X	X
Arbor	Thread															
M24	1/2-20								X		X					
M24K	1/2-20	X							X					X		
M34	1/2-20			X		X	X	X		X		X	X			X
M35PS	5/8-18							X				X				
M44	1/2-20	X	X		X				X					X		
M45P	5/8-18	X	X	X	X	X			X	X	X		X	X	X	X
ME12-12"	Extension								X				X	X		X

ARBORS

These heavy-duty, carbon steel arbors come complete with pilot drills. They adapt Morse Hole Saws to any power drill used by professionals.

PACKAGING: 1 per box – or 1 per card, 2 per standard pack



SDS arbors are used in tools having SDS chucks, to drive hole saws in rotary hammers or hammer drills having a straight rotary option.



Arbors Complete with Pilot Drills

Product #	Computer #	Shank Size	Thread Size	Drill Number	Computer Number	Chuck Size	Fits Saws	Follow Through
M24K	140027	1/4 Round	1/2 - 20	MPD401	140775	1/4	*9/16" - 1-3/16"	3/4" - 1-1/2"
M24	140010	1/4 Hex	1/2 - 20	MPD4S01	140799	1/4	*9/16" - 1-3/16"	3/4" - 1-1/2"
M34	140041	3/8 Hex	1/2 - 20	MPD4S01	140799	3/8	*9/16" - 1-3/16"	3/4" - 1-1/2"
M44K	140089	7/16 Hex	1/2 - 20	MPD401	140775	1/2	9/16" - 6"	1-1/2" - 6"
M44	140072	7/16 Hex	1/2 - 20	MPD401	140775	1/2	*9/16" - 1-3/16"	3/4" - 1-1/2"
M35PS	140065	3/8 Hex	5/8 - 18	MPD4S01	140779	3/8	1-1/4" - 6"	1-1/2" - 6"
M45	140140	7/16 Hex	5/8 - 18	MPD401	140775	1/2	1-1/4" - 2-3/8"	1-1/4" - 2-3/8"
M45P	140164	7/16 Hex	5/8 - 18	MPD401	140775	1/2	1-1/4" - 6"	1-1/2" - 6"
M46PS	140201	7/16 Hex	5/8 - 18	MPD4S01	140799	1/2	1-1/4" - 6"	1-1/2" - 6"
M55P	140218	5/8 Hex	5/8 - 18	MPD401	140775	3/4	1-1/4" - 6"	1-1/2" - 6"
M34CT **	140898	3/8 Hex	1/2 - 20	MPD4SCT01	140874	3/8	3/4" - 1-3/16"	3/4" - 1-1/2"
M45PCT**	140904	7/16 Hex	5/8 - 18	MPD4CT01	140850	1/2	1-1/4" - 6"	1-1/2" - 6"
SDS5/8QC	140928	SDS	5/8 - 18	MPD4S01	140799	SDS	1-1/4" - 6"	1-1/2" - 6"
SDS1/2QC	140911	SDS	1/2 - 20	MPD4S01	140799	SDS	*9/16" - 1-3/16"	3/4" - 1-1/2"
Carded Arbors								
M24C	140058	1/4 Hex	1/2-20	MPD4S01	140799	1/4	*9/16" - 1-3/16"	3/4" - 1-1/2"
M24KC	140539	1/4 Round	1/2-20	MPD401	140775	1/4	*9/16" - 1-3/16"	3/4" - 1-1/2"
M34C	140546	3/8 Hex	1/2-20	MPD4S01	140799	3/8	*9/16" - 1-3/16"	3/4" - 1-1/2"
M35PSC	140553	3/8 Hex	5/8-18	MPD4S01	140799	3/8	1-1/4" - 6"	1-7/16" - 6"
M44C	140560	7/16 Hex	5/8-18	MPD401	140775	1/2	9/16" - 1-3/16"	3/4" - 1-1/2"
M45PC	140577	7/16 Hex	5/8-18	MPD401	140775	1/2	1-1/4" - 6"	1-1/2" - 6"

*Hole saws, AV204, AV224, AV244, require the use of one of the arbors marked with an asterisk.

**M34CT and M45PCT are carbide tipped for use with carbide tipped and carbide grit saws.



Fast-Adapt™ Chuck
Morse's Fast-Adapt Quick Change Chucks allow for fast keyless insertion and removal of any 1/4", 3/8", and 7/16" hex shank power tool accessories with standard power groove. Fits 3/8" and larger chucks.

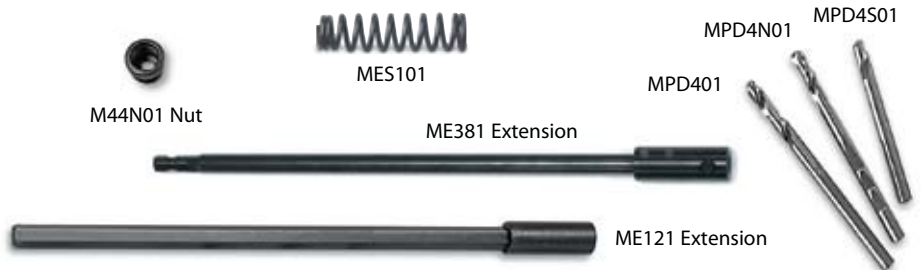

Pilot Drills and Accessories

Prod #	Comp #	Description
MPD401	140775	4-5/16" X 1/4" (110mm X 6.5mm) Pilot Drill, shank ground 3 sides, split point
MPD4N01	140782	4" X 1/4" (102mm X 6.5mm) Pilot Drill, 3 notches for set screw
MPD4S01	140799	3-1/16" X 1/4" (78mm X 6.5mm) Pilot Drill for M24, M34, M35PS arbors
TACPD4	120043	4-5/16" X 1/4" (110mm X 6.5mm) Pilot Drill, Carded, 10 per pack
TACPD4S	122047	3-1/16" X 1/4" (78mm X 6.5mm) Pilot Drill, Carded, 10 per pack
MPD4CT01	140850	4" X 1/4" (102mm X 6.5mm) Carbide Tipped Pilot Drill
MPD4SCT01	140874	2-7/8" X 1/4" (83mm X 6.5mm) Carbide Tipped Pilot Drill
MES101	140805	Ejector Spring, fits all 1/4" pilot drills
ME121	141123	12" (305mm) Extension for shank of 7/16" (10.5mm) arbors for 1/2" drill chuck
ME381	140409	12" (305mm) Extension for shank of 3/8" (9.5mm) arbors for 3/8" or larger drill chuck
M44N01 Nut	140751	Adapts arbors with 1/2 - 20 threads to fit hole saws with 5/8 - 18 threads
M44NH01	140744	Hex Adapter Nut
MQC14	140386	Fast-Adapt Chuck fits 3/8" & larger chucks. Use with 1/4" shanks
MQC38	140393	Fast-Adapt Chuck fits 3/8" & larger chucks. Use with 3/8" & 7/16" shanks

Arbor Kits

Prod #	Comp #	Contains
MK1	140331	1 M24K 1 MN1 Nut 1 M44K 1 MN2 Nut
MK2	140348	1 M24K 1 MN1 Nut 1 MN2 Nut
MK3	140355	1 M44K 1 MN1 1 MN2 Nut

Other pack quantities available. See current price list.

Attached 7/16" pass-through shank arbor is convenient and time-saving

Variable pitch positive rake teeth reduce vibration

and clear chips to improve cutting speed

M3 cutting edge teeth are shock resistant and longer lasting



1-1/2" cutting depth cuts through 2 x 4's

REAL McCOY® BI-METAL HOLE SAWS

A premium line of professional quality hole saws with a built-in arbor for cutting holes in wood, plastic, or any machinable metal including nail-embedded wood, plywood, pipe and stainless steel. Requires 4-5/16" pilot drill. See page 12.

PACKAGING: 1 per box
1 per card, 2 cards per standard pack

Diameter*		Product Number				Pipe Tap Size Inches	Pipe Ent. Size Inches	Diameter*		Product Number				Pipe Tap Size Inches	Pipe Ent. Size Inches
Inches	mm	Boxed Prod. #	Boxed Comp #	Carded Prod. #	Carded Comp #			Inches	mm	Boxed Prod. #	Boxed Comp #	Carded Prod. #	Carded Comp #		
9/16	14	TA09	110099	TAC09	120098			2-1/8	54	TA34	110341	TAC34	120340		
5/8	16	TA10	110105	TAC10	120104				55	TA345	115346				
	16	TA105	115100					2-1/4	57	TA36	110365	TAC36	120364	2	
11/16	17	TA11	110112	TAC11	120111			2-5/16	59	TA37	110372	TAC37	120371		
3/4	19	TA12	110129	TAC12	120128	1/2	3/8	2-3/8	60	TA38	110389	TAC38	120388		
	20	TA125	115124					2-1/2	64	TA40	110402	TAC40	120401		2
13/16	21	TA13	110136	TAC13	120135			2-9/16	65	TA41	110419	TAC41	120418		
7/8	22	TA14	110143	TAC14	120142	3/4	1/2	2-5/8	67	TA42	110426	TAC42	120425	2-1/2	
15/16	24	TA15	110150	TAC15	120159				68	TA425	115421				
	25	TA155	115155						68.5	TA435	115438				
1	25	TA16	110167	TAC16	120166			2-3/4	70	TA44	110440	TAC44	120449		
1-1/16	27	TA17	110174	TAC17	120173			2-7/8	73	TA46	110464	TAC46	120463		
1-1/8	29	TA18	110181	TAC18	120180	1	3/4		75	TA475	115476				
	30	TA185	115186					3	76	TA48	110488	TAC48	120487		2-1/2
1-3/16	30	TA19	110198	TAC19	120197			3-1/8	79	TA50	110501	TAC50	120500		
1-1/4	32	TA20	110204	TAC20	120203			3-1/4	83	TA52	110525	TAC52	120524	3	
	32	TA205	115209					3-3/8	86	TA54	110549	TAC54	120548		
1-5/16	33	TA21	110211	TAC21	120210			3-1/2	89	TA56	110563	TAC56	120562		
1-3/8	35	TA22	110228	TAC22	120227		1	3-5/8	92	TA58	110587	TAC58	120586		3
	35	TA225	115223					3-3/4	95	TA60	110600	TAC60	120609	3-1/2	
1-7/16	37	TA23	110235	TAC23	120234	1-1/4		3-7/8	98	TA62	110624	TAC62	120623		
1-1/2	38	TA24	110242	TAC24	120241				100	TA63	110631				
1-9/16	40	TA25	110259	TAC25	120258			4	102	TA64	110648	TAC64	120647		
	40	TA255	115254					4-1/8	105	TA66	110662	TAC66	120661		3-1/2
1-5/8	41	TA26	110266	TAC26	120265			4-1/4	108	TA68	110686	TAC68	120913	4	
1-11/16	43	TA27	110273	TAC27	120272			4-3/8	111	TA70	110709	TAC70	120920		
1-3/4	44	TA28	110280	TAC28	120289	1-1/2	1-1/4	4-1/2	114	TA72	110723	TAC72	120937		4
	45	TA285	115285					4-3/4	121	TA76	110761	TAC76	120944	4-1/2	
1-13/16	46	TA29	110297	TAC29	120296			5	127	TA80	110808	TAC80	120951		
1-7/8	48	TA30	110303	TAC30	120302			5-1/2	140	TA88	110884	TAC88	120968		
	50	TA315	115315					5-3/4	146	TA92	110921	TAC92	120975		
2	51	TA32	110327	TAC32	120326		1-1/2	6	152	TA96	110969	TAC96	120982		
2-1/16	52	TA33	110334	TAC33	120333										

* Metric sizes shown in red are exact millimeter sizes. Metric sizes in black are approximate metric equivalents of exact inch sizes.



THE REAL McCOY® DEEP CUTTING HOLE SAWS

The 1-7/8" cutting depth provides extra depth for specialty cuts made by locksmiths, remodelers and general contractors alike. Easily cuts through 2 x 4's, joists and most doors in one pass with extra clearance.

PACKAGING: 1 per box

7/16" hex shank arbor

Diameter		Product #	Comp #	Pipe Tap Size Inches	Pipe Ent. Size Inches	Diameter		Product #	Comp #	Pipe Tap Size Inches	Pipe Ent. Size Inches
Inches	mm					Inches	mm				
3/4	19	TAD12	123006		3/8	2-3/8	60	TAD38	123242		
13/16	21	TAD13	123013			2-1/2	64	TAD40	123259		2
7/8	22	TAD14	123020	3/4	1/2	2-9/16	65	TAD41	123266		
15/16	24	TAD15	123037			2-5/8	67	TAD42	123273	2-1/2	
1	25	TAD16	123044			2-3/4	70	TAD44	123280		
1-1/16	27	TAD17	123051			2-7/8	73	TAD46	123297		
1-1/8	29	TAD18	123068	1	3/4	3	76	TAD48	123303		2-1/2
1-3/16	30	TAD19	123075			3-1/8	79	TAD50	123310		
1-1/4	32	TAD20	123082			3-1/4	83	TAD52	123327	3	
1-5/16	33	TAD21	123099			3-3/8	86	TAD54	123334		
1-3/8	35	TAD22	123105		1	3-1/2	89	TAD56	123341		
1-7/16	37	TAD23	123112	1-1/4		3-5/8	92	TAD58	123358		3
1-1/2	38	TAD24	123129			3-3/4	95	TAD60	123365	3-1/2	
1-9/16	40	TAD25	123136			3-7/8	98	TAD62	123372		
1-5/8	41	TAD26	123143			4	102	TAD64	123389		
1-11/16	43	TAD27	123150			4-1/8	105	TAD66	123396		3-1/2
1-3/4	44	TAD28	123167	1-1/2	1-1/4	4-1/4	108	TAD68	123402	4	
1-13/16	46	TAD29	123174			4-3/8	111	TAD70	123419		
1-7/8	48	TAD30	123181			4-1/2	114	TAD72	123426		4
2	51	TAD32	123198		1-1/2	4-3/4	121	TAD76	123433	4-1/2	
2-1/16	52	TAD33	123204			5	127	TAD80	123440		
2-1/8	54	TAD34	123211			5-1/2	140	TAD88	123457		
2-1/4	57	TAD36	123228	2		5-3/4	146	TAD92	123464		
2-5/16	59	TAD37	123235			6	152	TAD96	123471		

The Real McCoy® Hole Saws

HOLE CUTTING & BORING TOOLS

**THE REAL McCOY® BI-METAL
VARIABLE PITCH HOLE SAW KITS**

These handy kits conveniently organize popular hole saw sizes for professional needs.

Standard Kits offer 1-1/2" cutting depth. 7/16" hex shank arbor.
Deep Cut Kits offer 1-7/8" cutting depth. 7/16" hex shank arbor.
For comparable metric sizes see charts on page 15.



ELECTRICIANS KIT: TA02E / 111027
DEEP CUT ELECTRICIANS KIT: TAD02E / 123495

Entrance sizes to 2"
Saws (1 each): 7/8", 1-1/8", 1-3/8", 1-3/4", 2", 2-1/2"
Pilot Drills (3): 4-5/16"



PLUMBERS KIT: TA04P / 111041
DEEP CUT PLUMBERS KIT: TAD04P / 123518

Contains pipe tap sizes for pipe through 2".
Saws (1 each): 3/4", 7/8", 1-1/8", 1-1/2", 1-3/4", 2-1/4"
Pilot Drills (3): 4-5/16"



MAINTENANCE KIT: TA01 / 111010
DEEP CUT MAINTENANCE KIT: TAD01 / 123488

A handy general purpose kit for industrial, general purpose, plumbing and electrical jobs on pipe and conduit through 2".
Saws (1 each): 3/4", 7/8", 1-1/8", 1-3/8", 1-1/2", 1-3/4", 2", 2-1/4", 2-1/2"
Pilot Drills (4): 4-5/16"
Extension (1): 12"
(1) Flat Head Screwdriver



MECHANICS KIT: TA05M / 111058

The 5 most popular hole saw sizes for construction, industrial and automotive aftermarket jobs.
Saws (1 each): 7/8", 1", 1-1/8", 1-1/4", 1-1/2"
Pilot Drills (1): 4-5/16"



LOCKSMITHS KIT: TA03L / 111034
DEEP CUT LOCKSMITHS KIT: TAD03L / 123501

Contains sizes for installation of popular locks, deadbolts, etc.
Saws (1 each): 3/4", 7/8", 1", 1-3/8", 1-1/2", 1-5/8", 1-3/4", 2-1/8"
Pilot Drills (4): 4-5/16"
(1) Flat Head Screwdriver



LOCK INSTALLATION KIT: TACKIT1 / 121019

The 2 most popular sizes for lock installation to assure accurate installation in wood or metal doors.
Saws (1 each): 1", 2-1/8"
Pilot Drills (1): 4-5/16"
Packed: 1 kit per card, 2 per standard pack



HOME OWNERS UTILITY KIT: TAHUK01 / 110006

Specially designed for homeowners' most common uses including installation of locks and cable wires.
Saws (1 each): 3/4", 1", 1-1/2", 2-1/8"
Pilot Drills (1): 4-5/16"

KIT CONTENT COMPARISON CHART FOR TA HOLE SAW KITS



Diameter		TA02E *	TA04P *	TA01 *	TA05M	TA03L *	TA06KIT1	TA0UK01
Inches	mm							
3/4	19		X	X		X		X
7/8	22	X	X	X	X	X		
1	25				X	X	X	
1-1/8	29	X	X	X	X			
1-1/4	32				X			
1-3/8	35	X		X		X		
1-1/2	38		X	X	X	X		X
1-5/8	41					X		
1-3/4	44	X	X	X		X		
2	51	X		X				
2-1/8	54					X	X	X
2-1/4	57		X	X				
2-1/2	64	X		X				
Additional Items								
Pilot Drills								
4-5/16"	110	3	3	4	1	4	1	1
ME12-12" Extension				X				
Screwdriver				X		X		

* Also Available as Deep Cut Kits (TAD Model Numbers.)



COMBINATION HOLE SAW KITS

We've integrated various hole saws to provide more advanced cutting solutions for professionals. Morse Master Cobalt® bimetal hole saws are provided in both kits for smooth cuts in wood, plastic, stainless steel, nail-embedded wood and other machinable metals.

ELECTRICIAN'S COMBINATION KIT: AVELE01 / 169776

The AVELE01 offers 16 bimetal and 9 carbide tipped hole saws in one convenient kit offering a broad range of popular diameters used by electricians. The carbide tipped hole saws included in this kit are designed for fast cuts in abrasive materials. Applications include fiberglass, drywall, aluminum and countertops.



PLUMBER'S COMBINATION KIT: AVPLU01 / 169783

For plumbers, M. K. Morse combined 13 bimetal and 9 carbide grit hole saws with diameters for cutting requirements through pipe tap and entrance sizes up to 4 inches (102mm). Carbide grit hole saws provide clean cuts in thin materials and cut very hard, abrasive materials such as hardened steel, cast iron, brick, cement, ceramics, computer flooring, composites and acoustic tile.

	3/4"	7/8"	1"	1-1/8"	1-1/4"	1-3/8"	1-1/2"	1-3/4"	2"	2-1/8"	2-1/4"	2-1/2"	2-9/16"	2-11/16"	3"	3-1/2"	3-5/8"	4"	4-1/8"	4-1/4"	4-1/2"	4-3/4"	Arbors	Pilot Drills
AVELE01	•	•	•	•	•	•	•	•	•	•	•	•	•	•	•	•	•	•	•	•	•	•		
BI-METAL	•	•	•	•	•	•	•	•	•	•	•	•	•	•	•	•	•	•	•	•	•	•		
CARBIDE TIP	•	•	•	•	•	•	•	•	•	•	•	•	•	•	•	•	•	•	•	•	•	•	M34	HSS (2)
	•	•	•	•	•	•	•	•	•	•	•	•	•	•	•	•	•	•	•	•	•	•	M35PS	3-1/4"
AVPLU01	•	•	•	•	•	•	•	•	•	•	•	•	•	•	•	•	•	•	•	•	•	•		
BI-METAL	•	•	•	•	•	•	•	•	•	•	•	•	•	•	•	•	•	•	•	•	•	•		
CARBIDE GRIT	•	•	•	•	•	•	•	•	•	•	•	•	•	•	•	•	•	•	•	•	•	•	M24	HSS(2) 3-1/16"
	•	•	•	•	•	•	•	•	•	•	•	•	•	•	•	•	•	•	•	•	•	•	M46PS	CT (2) 2-7/8"



SPADE BITS

A popular item for boring small holes through wood. Angled spur design cuts accurate holes cleanly and quickly. Stem works with 1/4" Fast-Adapt™



PACKAGING: 1 per card, 5 per standard pack

Description	10/Box		1/Card		Description	10/Box		1/Card	
	Product #	Computer #	Product #	Computer #		Product #	Computer #	Product #	Computer #
1/4" 6mm	WSB250	125000	WSB250C	125307	13/16" 21mm	WSB812	125093	WSB812C	125390
5/16" 8mm	WSB312	125017	WSB312C	125314	7/8" 22mm	WSB875	125109	WSB875C	125406
3/8" 10mm	WSB375	125024	WSB375C	125321	15/16" 24mm	WSB937	125116	WSB937C	125413
7/16" 11mm	WSB437	125031	WSB437C	125338	1" 25mm	WSB1000	125123	WSB1000C	125420
1/2" 13mm	WSB500	125048	WSB500C	125345	1-1/8" 29mm	WSB1125	125130	WSB1125C	125437
9/16" 14mm	WSB562	125055	WSB562C	125352	1-1/4" 32mm	WSB1250	125147	WSB1250C	125444
5/8" 16mm	WSB625	125062	WSB625C	125369	1-3/8" 35mm	WSB1375	125154	WSB1375C	125451
11/16" 17mm	WSB687	125079	WSB687C	125376	1-1/2" 38mm	WSB1500	125161	WSB1500C	125468
3/4" 19mm	WSB750	125086	WSB750C	125383					

STEP DRILLS

An excellent tool for electrical contractors, sheetmetal workers and auto mechanics. Step drills are ideal for drilling repetitive holes in steel, copper, brass, plastic, plexiglas and other thin materials. Made of high speed steel with double fluted ground cutting edge for long life. **TiN (Titanium Nitride)** coated step drills are offered in our most popular sizes.

The coating on these step drills allows them to last up to six times longer than those made without TiN coating.



Description	1/Tube		Shank Inches	Point Type
	Product #	Computer #		
1/8" - 1/2" by 32nds	ESD01	124003	1/4	Self-Starting
3/16" - 1/2" by 16ths	ESD02	124010	1/4	Self-Starting
3/16" - 7/8" by 16ths	ESD03	124027	3/8	Self-Starting
1/4" - 3/4" by 16ths	ESD04	124034	3/8	Self-Starting
1/4" - 1-1/8" by 16ths	ESD05	124041	3/8	Self-Starting
1/8" - 3/8" by 16ths	ESD06	124058	1/4	Self-Starting
1/8" - 1/2" by 16ths	ESD07	124065	1/4	Self-Starting
9/16" - 1" by 16ths	ESD08	124072	3/8	Hole Enlarging 1/2" or larger Pilot Holes
3/4" - 1-3/8" by 16ths	ESD09	124089	1/2	Hole Enlarging 3/4" or larger Pilot Holes
1/4" - 7/8" by 16ths	ESD10	124096	3/8	Self-Starting
1/4" - 1-3/8" by 8ths	ESD11	124102	3/8	Self-Starting
TiN Coated Step Drills				
1/8" - 1/2" by 32nds	ESD01TiN	124119	1/4	Self-Starting
3/16" - 1/2" by 16ths	ESD02TiN	124126	1/4	Self-Starting
3/16" - 7/8" by 16ths	ESD03TiN	124133	3/8	Self-Starting
1/4" - 3/4" by 16ths	ESD04TiN	124140	3/8	Self-Starting

STEP DRILL KIT: ESDKIT01 / 124201

This kit offers 4 of the most popular step drill sizes for electrical, automotive and sheet metal applications. Contains: ESD01, ESD03, ESD04, ESD05



DOUBLE CUT AUGER BITS

These premium double fluted auger bits provide an excellent deep boring option in wood and nail-embedded wood applications. All Morse carbon steel auger bits have a self-feed screw point for effortless boring, and double-flute design for fast chip removal. Precision ground, heat-treated and tempered cutting edges cut through nails and are resharpenable. PACKAGING: 1 per tube

Self feeding screw point for easy starting

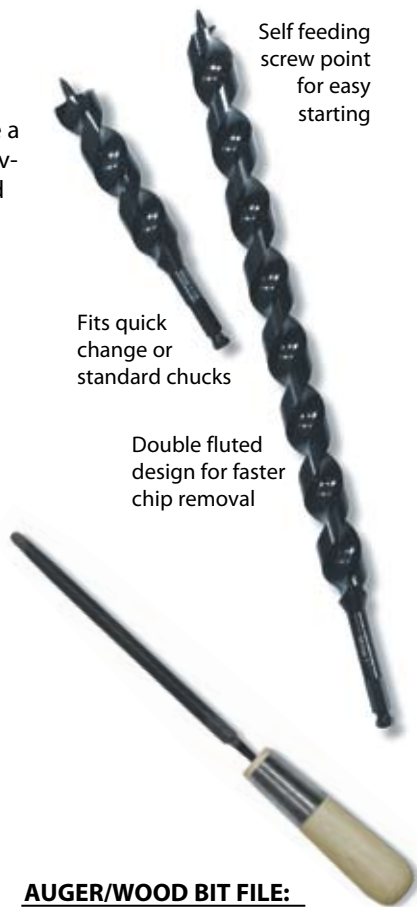

Fits quick change or standard chucks

Double fluted design for faster chip removal

Bore Diameter		Length	Shank Size	Part Number	Computer #
Inches	mm				
3/8"	9.5	18"	7/16"*	WSAB180375	125505
7/16"	11	18"	7/16"*	WSAB180437	125512
1/2"	13	18"	7/16"*	WSAB180500	125529
9/16"	14	18"	7/16"*	WSAB180562	125536
5/8"	16	18"	7/16"*	WSAB180625	125543
11/16"	17	18"	7/16"*	WSAB180687	125550
3/4"	19	18"	7/16"*	WSAB180750	125567
13/16"	21	18"	7/16"*	WSAB180812	125574
7/8"	22	18"	7/16"*	WSAB180875	125581
15/16"	24	18"	7/16"*	WSAB180937	125598
1"	25	18"	7/16"*	WSAB181000	125604
1-1/16"	27	18"	7/16"*	WSAB181062	125611
1-1/8"	29	18"	7/16"*	WSAB181125	125628
1-1/4"	32	18"	7/16"*	WSAB181250	125635
1-3/8"	35	18"	7/16"*	WSAB181375	125642
1-1/2"	38	18"	7/16"*	WSAB181500	125659
5/8"	16	7-1/2"	7/16"*	WSAB750625	125666
11/16"	17	7-1/2"	7/16"*	WSAB750687	125673
3/4"	19	7-1/2"	7/16"*	WSAB750750	125680
13/16"	21	7-1/2"	7/16"*	WSAB750812	125697
7/8"	22	7-1/2"	7/16"*	WSAB750875	125703
15/16"	24	7-1/2"	7/16"*	WSAB750937	125710
1"	25	7-1/2"	7/16"*	WSAB751000	125727
1-1/8"	29	7-1/2"	7/16"*	WSAB751125	125734
1-1/4"	32	7-1/2"	7/16"*	WSAB751250	125741
1-3/8"	35	7-1/2"	7/16"*	WSAB751375	125758
1-1/2"	38	7-1/2"	7/16"*	WSAB751500	125765

* Shanks are designed to work in Fast-Adapt™ MQC38 quick change chucks (pg 10) and standard chucks.

AUGER/WOOD BIT FILE: WSAB6STFILE / 125499

These files are designed for sharpening and extending the life of Morse auger and wood bits. Six inch slim taper file with attached wooden handle. PACKAGING: 1 per tube

SELF FEEDING WOOD BITS

Morse self feeding wood bits are precision ground for clean, accurate holes. They are designed with a threaded feed screw tip and a single chip lifter for fast, efficient chip removal. These bits can be resharpened using the Morse Auger/Wood bit file. PACKAGING: 1 per tube



Bore Diameter		Shank Size	Part Number	Computer #
Inches	mm			
1"	25	7/16"*	WSF1000	123822
1-1/8"	29	7/16"*	WSF1125	123839
1-1/4"	32	7/16"*	WSF1250	123846
1-3/8"	35	7/16"*	WSF1375	123853
1-1/2"	38	7/16"*	WSF1500	123860
1-3/4"	44	7/16"*	WSF1750	123877
2"	51	7/16"*	WSF2000	123884
2-1/8"	54	7/16"*	WSF2125	123891
2-1/4"	57	7/16"*	WSF2250	123907
2-9/16"	65	7/16"*	WSF2562	123914
3"	76	7/16"*	WSF3000	123921
3-5/8"	92	7/16"*	WSF3625	123938
4-5/8"	118	7/16"*	WSF4625	123945
5-1/2" Extension		7/16"*	WSFEXT5	123990
Self Feeding Wood Bit Kits				
4 Piece Contractor Kit			WSFKIT1	123952
Contains: 1-3/8", 1-1/2", 2-1/8", 2-9/16"				
8 Piece Contractor Kit			WSFKIT2	123969
Contains: 1", 1-1/8", 1-1/4", 1-3/8", 1-1/2", 1-3/4", 2-1/8", 2-9/16", 5-1/2" Extension				
Screw Tip Replacement Kits				
For 1" to 2-9/16" (25-65mm) bits			WSFRKIT1	123976
Contains: 3 screw tips, 1 set screw, 1 hex key				
For 3" to 4-5/8" (76-117mm) bits			WSFRKIT2	123983
Contains: 3 screw tips, 1 set screw, 1 hex key				

* Shanks are designed to work in Fast-Adapt™ MQC38 quick change chuck adaptors (pg 12) and standard chucks.

RECIPROCATING SAW BLADES

Morse blades make reciprocating saws more productive. These top quality blades are used on everything from rough framing to fire and rescue activities. You'll find Morse blades last longer while cutting wood, metals, plastics, tiles, soil pipe and anything else a busy professional might need to cut. These blades are manufactured in the world's most advanced saw blade manufacturing plant using processes that have been developed, improved and refined over years to produce safe, long lasting saw blades.



Master Cobalt®	Bi-Metal Blades	The Real McRipper®	Fire & Rescue Bi-Metal	U-Shank Bi-Metal	Tungsten Carbide Tip	Tungsten Carbide Grit	Air Saws
Blade Type		Application					
Master Cobalt® Bi-Metal		All types of machinable metal, wood, nail-embedded wood, composites, plastic, rubber. Special heat treat produces super tough, super wear resistant heavy duty blades for longer life in toughest cutting applications.					
Bi-Metal		All types of machinable metal, wood, nail-embedded wood, composites, plastic, rubber.					
Real McRipper® Bi-Metal		General demolition work. Wood, nail-embedded wood, roofs, walls, metal studs, wallboard, plaster, lath. Extra wide, extra thick blades for stability and control when cutting through structures like walls and roofs.					
Fire & Rescue Bi-Metal		All types of machinable metal encountered in vehicle extraction and demolition. Extra wide, extra thick blades for heavy feed and stability. Available in fine tooth pitches for superior performance in sheet metal and vehicle frames.					
U-Shank Bi-Metal		All types of machinable metal. For use in pipe clamp recip machines from Ridgid, REMS, Roller, Pace, and Flex.					
Tungsten Carbide Tipped		Fast cutting in nail free wood, plastic, drywall, fiberboard, fiberglass, and other soft abrasive material.					
Tungsten Carbide Grit Edge		Extremely hard or abrasive material like hardened steel, foamed glass, brick, tile, ceramics, cement, fiberglass, and wire reinforced rubber.					
Bi-Metal Air Saw Blades		Fine toothed blade used in pneumatic saws to cut thin sheet metal.					

MASTER COBALT® RECIPROCATING SAW BLADES

The best blades in the world for cutting wood and metal, including steel, stainless steel, iron, sheetmetal and pipe. Master Cobalt® technology was painstakingly developed in the Morse Technology Center. Here we have tested the many variables affecting blade life and have discovered a unique combination of features that has tripled the life of standard reciprocating saw blades.

These are the longest lasting recips available. They cut more smoothly, more accurately and offer greater value. They are Master Cobalt®, available exclusively from M. K. Morse.

Master Cobalt® Reciprocating Saw Blades have conventional shanks.

A wide variety of sizes brings long life cutting action to almost every professional cutting need.

Available in 3 different thicknesses to meet flexibility and stiffness needs for various applications.

8% cobalt cutting edge is electron-beam welded to high strength steel backer for greater wear resistance and longer life.

RECIPROCATING SAW BLADES
 Master Cobalt® Bi-Metal Blades



Recommended Use	Description	Teeth Per Inch	25/Tube		5/Tube	
			Product #	Computer #	Product #	Computer #
	.035 THICK BLADES					
Wood, nail-embedded wood, compositions, plastic, cast aluminum, and non-ferrous metals.	6" X 3/4" X .035 BIM MC	10	RBMC610T25	404037	RBMC610T05	404020
	8" X 3/4" X .035 BIM MC	10	RBMC810T25	404112	RBMC810T05	404105
Heavy gauge metals 1/8" thick and above. Barstock and angles.	6" X 3/4" X .035 BIM MC	14	RBMC614T25	404051	RBMC614T05	404044
	8" X 3/4" X .035 BIM MC	14	RBMC814T25	404136	RBMC814T05	404129
Heavy gauge metals of 18 gauge to 1/8" thick, conduit, pipe, channels, and tubing.	6" X 3/4" X .035 BIM MC	18	RBMC618T25	404075	RBMC618T05	404068
	8" X 3/4" X .035 BIM MC	18	RBMC818T25	404150	RBMC818T05	404143
	12" X 3/4" X .035 BIM MC	18	RBMC1218T25	404013	RBMC1218T05	404006
Metal cutting 18 gauge and under. Trim and tubing.	6" X 3/4" X .035 BIM MC	24	RBMC624T25	404099	RBMC624T05	404082
	.042 THICK BLADES					
Heavy duty metal cutting, nail-embedded woods, pallets.	6" X 1" X .042 BIM MC	10	RBMC64210T25	404174	RBMC64210T05	404167
	9" X 1" X .042 BIM MC	10	RBMC94210T25	403894	RBMC94210T05	403887
	12" X 1" X .042 BIM MC	10	RBMC124210T25	403955	RBMC124210T05	403948
Heavy gauge metals 1/8" thick and above. Barstock and angles.	6" X 1" X .042 BIM MC	14	RBMC64214T25	404198	RBMC64214T05	404181
	9" X 1" X .042 BIM MC	14	RBMC94214T25	403917	RBMC94214T05	403900
	12" X 1" X .042 BIM MC	14	RBMC124214T25	403979	RBMC124214T05	403962
Heavy gauge metals of 18 gauge to 1/8" thick, conduit, pipe, channels, and tubing.	6" X 1" X .042 BIM MC	18	RBMC64218T25	404211	RBMC64218T05	404204
	9" X 1" X .042 BIM MC	18	RBMC94218T25	403931	RBMC94218T05	403924
	12" X 1" X .042 BIM MC	18	RBMC124218T25	403993	RBMC124218T05	403986
Metal cutting 18 gauge and under. Trim and tubing.	6" X 1" X .042 BIM MC	24	RBMC64224T25	404235	RBMC64224T05	404228
	.050 THICK BLADES					
Long life cutting wood.	6" X 3/4" X .050 BIM MC	5.5	RBMC65005T25	404471	RBMC65005T05	404440
	9" X 3/4" X .050 BIM MC	5.5	RBMC95005T25	404488	RBMC95005T05	404457
	12" X 3/4" X .050 BIM MC	5.5	RBMC125005T25	404495	RBMC125005T05	404464
Heavy duty metal cutting, nail-embedded woods.	9" X 1" X .050 BIM MC	10	RBMC95010T25	404310	RBMC95010T05	404303
	12" X 1" X .050 BIM MC	10	RBMC125010T25	404259	RBMC125010T05	404242
Heavy duty metal cutting 1/8" thick and above. Barstock and angles.	9" X 1" X .050 BIM MC	14	RBMC95014T25	404334	RBMC95014T05	404327
	12" X 1" X .050 BIM MC	14	RBMC125014T25	404273	RBMC125014T05	404266
Long life cutting heavy gauge metals of 18 gauge to 1/8" thick, conduit, pipe, channels, and tubing.	9" X 1" X .050 BIM MC	18	RBMC95018T25	404358	RBMC95018T05	404341
	12" X 1" X .050 BIM MC	18	RBMC125018T25	404297	RBMC125018T05	404280

RECIPROCATING SAW BLADES

Bi-Metal Reciprocating Saw Blades



Application	Length X Width X Thickness		T. P. I.	50/Tube		25/Tube		15/Tube		5/Tube		2/Card 5/Standard Pk	
	Inches	mm		Product #	Comp#	Product #	Comp#	Product #	Comp#	Product #	Comp #	Product #	Comp #
Wood, nail-embedded wood, all composition material.	6 X 3/4 X .035	150 X 20 X .9	6	RB606ST50	402125					RB606ST05	402132	RB606STC2	397261
Demolition, nail-embedded wood, all wood	12 X 3/4 X .050	300 X 20 X 1.3	2/3	RB125023T50	401616					RB125023T05	401593		
General rough-in, all woods, nail-embedded woods.	6 X 3/4 X .035	150 X 20 X .9	6	RB63506T50	400183	RB63506T25	398718	RB63506T15	398404	RB63506T05	400190	RB65006C2	397339
	9 X 3/4 X .035	225 X 20 X .9	6	RB93506T50	400169					RB93506T05	400176		
	12 X 3/4 X .035	300 X 20 X .9	6	RB123506T50	400145					RB123506T05	400152		
	6 X 3/4 X .050	150 X 20 X 1.3	6	RB65006T50	402057					RB65006T05	402040		
	9 X 3/4 X .050	225 X 20 X 1.3	6	RB95006T50	402033					RB95006T05	402026		
	12 X 3/4 X .050	300 X 20 X 1.3	6	RB125006T50	402149					RB125006T05	402156		
General rough-in, all woods, nail-embedded woods.	12 X 3/4 X .050	300 X 20 X 1.3	5/8	RB125058T50	398442					RB65058T05	398510		
	6 X 3/4 X .050	150 X 20 X 1.3	5/8	RB65058T50	398503								
Wood, nail-embedded wood, all composition material.	12 X 3/4 X .050	300 X 20 X 1.3	5/8	RB658T50	398558					RB125058TT05	398473		
General purpose, metal cutting, nail-embedded woods.	8 X 3/4 X .050	200 x 20 x 1.3	8/12	RB850812T50	400947					RB850812T05	400930		
General purpose, metal cutting, nail-embedded woods.	12 X 3/4 X .050	300 X 20 X 1.3	8/12	RB1250812T50	400923					RB1250812T05	400916		
	12 X 3/4 X .035	300 X 20 X .9	10/14	RB121014T50	400107					RB121014T05	400114		
Heavy duty metal cutting, nail-embedded woods.	6 X 3/4 X .050	150 X 20 X 1.3	10/14	RB6501014TT50	398534					RB6501014TT05	398541		
General rough-in, all woods, nail embedded woods.	12 X 3/4 X .050	300 X 20 X 1.3	10/14	RB12501014T50	402088	RB12501014T25	398640			RB12501014T05	402095	RB12501014C*	402248
Heavy gauge metal, rubber & fiber, nail-embedded wood.	4 X 3/4 X .035	100 X 20 X .9	10/14	RB41014T50	402606					RB41014T05	402613		
Wood, nail-embedded wood, compositions, plastic, metals 1/8" and above.	6 X 3/4 X .035	150 X 20 X .9	10/14	RB61014T50	402019					RB61014T05	402002		
Heavy duty wood/metal cutting.	6 X 3/4 X .050	150 X 20 X 1.3	10/14	RB6501014T50	399227					RB6501014T05	399234	RB6501014C2	397360
General purpose, metal cutting, nail-embedded woods.	8 X 3/4 X .035	200 X 20 X .9	10/14	RB81014T50	402101	RB81014T25	398756	RB81014T15	398411	RB81014T05	402118	RB81014C2	397407
Heavy duty metal cutting, nail-embedded woods.	12 X 3/4 X .050	300 X 20 X 1.3	10/14	RB12501014STT50	398428					RB12501014STT05	398435		
For soil pipe.	8 X 3/4 X .050	200 X 20 X 1.3	10/14	RB8501014T50	402064					RB8501014T05	402071	RB8501014C2	397384
Wood, nail-embedded wood, compositions, plastic, cast aluminum, and non-ferrous metals.	6 X 3/4 X .035	150 X 20 X .9	10	RB610T50	400381	RB610T25	398664			RB610T05	400398	RB610C2	397285
	12 X 3/4 X .035	300 X 20 X .9	10	RB1210T50	400244			RB1210T05	400251				
	8 X 3/4 X .035	200 X 20 X .9	10	RB810T50	400466			RB810T25	398749	RB810T05	400473		
All woods, composition materials, plastic, nail-embedded wood, cast aluminum, light-gauge metals.	10 X 3/4 X .035	250 X 20 X .9	10	RB1010T50	402569					RB1010T05	402576		
	6 X 3/4 X .050	150 X 20 X 1.3	10	RB65010T50	399593					RB65010T05	399609		
Heavy gauge metals 1/8" thick and above. Barstock and angles.	4 X 3/4 X .035	100 X 20 X .9	14	RB414T50	400220	RB614T25	398671	RB614T15	398381	RB414T05	400237	RB614C2	397308
	6 X 3/4 X .035	150 X 20 X .9	14	RB614T50	400404					RB614T05	400411		
	8 X 3/4 X .035	200 X 20 X .9	14	RB814T50	400480					RB814T05	400497		
	9 X 3/4 X .035	225 X 20 X .9	14	RB914T50	400992					RB914T05	400985		
	12 X 3/4 X .035	300 X 20 X .9	14	RB1214T50	400121					RB1214T05	400138		
Heavy duty metal cutting 1/8" thick and above.	6 X 3/4 X .050	150 X 20 X 1.3	14	RB65014T50	399616					RB65014T05	399623		
Heavy gauge metals of 18 gauge to 1/8" thick, conduit, pipe, channels, and tubing.	4 X 3/4 X .035	100 X 20 X .9	18	RB418T50	400268	RB618T25	398688	RB618T15	398398	RB418T05	400275	RB418C2	397247
	6 X 3/4 X .035	150 X 20 X .9	18	RB618T50	400428					RB618T05	400435		
	8 X 3/4 X .035	200 X 20 X .9	18	RB818T50	402583					RB818T05	402590		
	9 X 3/4 X .035	225 X 20 X .9	18	RB918T50	401012					RB918T05	401005		
	10 X 3/4 X .035	250 X 20 X .9	18	RB1018T50	398480					RB1018T05	398497		
	12 X 3/4 X .035	300 X 20 X .9	18	RB1218T50	400206					RB1218T05	400213		
Heavy duty metal cutting 18 gauge to 1/8" thick.	6 X 3/4 X .050	150 X 20 X 1.3	18	RB65018T50	399630					RB65018T05	399647		
Metal cutting 18 gauge and under. Trim and tubing. Galvanized pipe under 18 gauge.	4 X 3/4 X .035	100 X 20 X .9	24	RB424T50	400305	RB624T25	398701			RB424T05	400312	RB624C2	397322
	6 X 3/4 X .035	150 X 20 X .9	24	RB624T50	400442			RB624T05	400459				
Plaster with metal lath, plasterboard, sheet rock, plaster walls.	6 X 3/4 X .035	150 X 20 X .9	6	RB606PT50	400343					RB606PT05	400350		
General rough-in scroll cuts, all woods, nail-embedded woods.	6 X 7/16 X .050	150 X 11 X 1.3	6	RB65006CT50	399500					RB65006CT05	399517		
Scroll cuts in wood and cast aluminum, non-ferrous metals.	3 X 5/16 X .035	75 X 6 X .9	18	RB318ST50	401982					RB318ST05	401999		

*Denotes 1 per card.

THE REAL McRIPPER® DEMOLITION BLADES

Another Morse original. Specially designed for the toughest demolition jobs. Cuts all woods, nail-embedded wood and metals.



Description	Teeth Per Inch	20/Tube		3/Tube		1/Card 5/Standard Pack	
		Product #	Computer #	Product #	Computer #	Product #	Computer #
6" X 7/8" X .062	6	RB66206T20	398343	RB66206T03	398350		
9" X 7/8" X .062	6	RB96206T20	402415	RB96206T03	402422	RB96206C	397186
12" X 7/8" X .062	6	RB126206T20	398305	RB126206T03	398312	RB126206C	397209
6" X 7/8" X .062	10	RB66210T20	398367	RB66210T03	398374		
9" X 7/8" X .062	10	RB96210T20	402439	RB96210T03	402446		
12" X 7/8" X .062	10	RB126210T20	398329	RB126210T03	398336		

FIRE & RESCUE BLADES

When lives are on the line, only the best will do. These are the blades preferred by professional firefighters who know they can count on Morse.



Description	Teeth Per Inch	20/Tube		3/Tube		1/Card 5/Standard Pack	
		Product #	Computer #	Product #	Computer #	Product #	Computer #
6" X 7/8" X .062	10	RBFR66210WT20	403511	RBFR66210WT03	403665		
9" X 7/8" X .062	10	RBFR96210WT20	403528	RBFR96210WT03	403689		
12" X 7/8" X .062	10	RBFR126210WT20	403504	RBFR126210WT03	403702		
6" X 7/8" X .062	14	RBFR66214WT20	403542	RBFR66214WT03	403672	RBFR66214WC	397117
9" X 7/8" X .062	14	RBFR96214WT20	403559	RBFR96214WT03	403696	RBFR96214WC	397131
12" X 7/8" X .062	14	RBFR126214WT20	403535	RBFR126214WT03	403719	RBFR126214WC	397155

U-SHANK BI-METAL BLADES

Specially designed for sawing pipes and metal sections. Fits saws from manufacturers like REMS, Roller's, Ridgid and Flex.



Recommended Use	Length X Width X Thickness		Teeth Per Inch	5/Pouch	
	Inches	mm		Product #	Computer #
Cuts thin wall metal and plastic pipe up to 6" diameter.	12 X 1 X .050	300 X 25 X 1.3	6	RB1206P	403641
Cuts pipe up to 2" diameter.	5-1/2 X 1 X .062	140 X 25 X 1.6	8	RB5508P	400015
Cuts pipe up to 4" diameter.	8 X 1 X .062	200 X 25 X 1.6	8	RB808P	400053
Cuts pipe up to 6" diameter.	10-1/2 X 1 X .062	263 X 25 X 1.6	8	RB10508P	399975
Cuts thin wall metal and plastic pipe up to 6" diameter.	12 X 1 X .062	300 X 25 X 1.6	8	RB1208P	403610
Cuts thin wall metal and plastic pipe up to 2" diameter.	5-1/2 X 1 X .035	140 X 25 X .9	14	RB5514P	400039
Cuts thin wall metal and plastic pipe up to 4" diameter.	8 X 1 X .035	200 X 25 X .9	14	RB814P	400077
Cuts thin wall metal and plastic pipe up to 6" diameter.	12 X 1 X .035	300 X 25 X .9	14	RB1214P	403627

BI-METAL RECIP KITS & ASSORTMENT POUCH

Handy assortments of our most popular sizes in tough high-strength polystyrene boxes. Assortment Pouch has see-through vinyl side.



Description	Product #	Computer #	Contains
Contractor General Use Kit	RBKIT01	405003	(7) ea.: RB618, RB63506, RB658, RB610, RB614, RB61014
Contractor Heavy Duty Kit	RBKIT02	405010	(5) ea.: RB65058, RB65010, RB65014, RB65018 / (10) ea.: RB65006
Demolition Kit	RBKIT03	405027	(5) ea.: RB65006, RB65058, RB65010 / (4) ea.: RB66206 / (8) ea.: RB66210
Assortment Pouch	RBPO1	403030	(1) ea.: RB414, RB418, RB614, RB618, RB65006

TUNGSTEN CARBIDE TIPPED BLADES

For cutting abrasive materials such as fiberglass, particle board, cement board, nail-free wood, non-ferrous metals, plastic, drywall, fiberboard, and pressure treated lumber.



Recommended Use	Length X Width X Thickness		Teeth Per Inch	25/Tube		3/Tube		1/Card 5/Standard Pack	
	Inches	mm		Product #	Computer #	Product #	Computer #	Product #	Computer #
Plaster over lath, fiberglass, wood, non-ferrous metal, cement board, pressure treated lumber, hardwood, and particle board.	6 X 3/4 X .050	150 X 20 X 1.3	3	RTCT603T25	403122	RTCT603T03	403443	RTCT603C	403047
	6 X 3/4 X .050	150 X 20 X 1.3	6	RTCT606ST25	403139	RTCT606ST03	403450	RTCT606SC	403054
	9 X 3/4 X .050	225 X 20 X 1.3	3	RTCT903T25	403146	RTCT903T03	403467	RTCT903C	403061
	9 X 3/4 X .050	225 X 20 X 1.3	6	RTCT906T25	403153	RTCT906T03	403474	RTCT906C	403078
	12 X 3/4 X .050	300 X 20 X 1.3	3	RTCT1203T25	403108	RTCT1203T03	403481	RTCT1203C	403085
	12 X 3/4 X .050	300 X 20 X 1.3	6	RTCT1206T25	403115	RTCT1206T03	403498	RTCT1206C	403092

TUNGSTEN CARBIDE GRIT BLADES

Their super resistance to heat and shock make them ideal for cutting materials too hard or abrasive for standard bi-metal blades. Ideal for cutting hardened steel, formed glass, brick, tile, ceramics, cement, fiberglass, marble, steel, plaster & lathe, laminates, and composites.



Recommended Use	Length X Width X Thickness		25/Tube		3/Tube		1/Card 5/Standard Pack	
	Inches	mm	Product #	Computer #	Product #	Computer #	Product #	Computer #
Cutting fiberglass, lath, plaster, ceramics, soil pipe, laminates, marble and hardened steel.	4	100	RTCG4T25	402910	RTCG4T03	403368	RCTCG4	402750
	6	150	RTCG6T25	402927	RTCG6T03	403375	RCTCG6	402767
	8	200	RTCG8T25	402934	RTCG8T03	403382	RCTCG8	402774

JAB SAW

A versatile tool that accepts both reciprocating saw and hack saw blades to make a compact hand saw. Heavy duty ergonomic handle design allows for quick change of blades for various applications. Unlike fixed blade jab saws, worn blades can be easily replaced. Use for cutting plaster, drywall, wood and metal in confined spaces. Comes equipped with a 6" .050 thick 6 TPI bi-metal reciprocating saw blade.



PACKAGING: 1 per card / 6 cards per box

Description	Part Number	Computer #
Jab saw with 6" .050 6TPI blade	JSHRBC01	397063

BI-METAL AIR SAW BLADES



These blades are specially designed for use in pneumatic saws. Blades have fine teeth for cutting metal. Very popular within autobody/muffler shops or other metal fabricating shops.



Length X Width X Thickness		Teeth Per Inch	25/Tube		5/Tube	
Inches	mm		Product #	Computer #	Product #	Computer #
3 X 1/2 X .025	75 X 12.7 X .6	14	RBA314T25	398572	RBA314T05	398220
3 X 1/2 X .025	75 X 12.7 X .6	18	RBA318T25	398589	RBA318T05	398244
3 X 1/2 X .025	75 X 12.7 X .6	24	RBA324T25	398596	RBA324T05	398268
3 X 1/2 X .025	75 X 12.7 X .6	32	RBA332T25	398602	RBA332T05	398282
4 X 1/2 X .025	100 X 12.7 X .6	14	RBA414T25	397513	RBA414T05	397506
4 X 1/2 X .025	100 X 12.7 X .6	18	RBA418T25	397537	RBA418T05	397520
4 X 1/2 X .025	100 X 12.7 X .6	24	RBA424T25	397551	RBA424T05	397544
4 X 1/2 X .025	100 X 12.7 X .6	32	RBA432T25	397575	RBA432T05	397568

JIG SAW ACCESSORIES

These safe, smooth-cutting blades cut quickly through a wide variety of materials. Different blade shapes and tooth configurations make sure you have the right blade for any job, whether you are making straight or contoured cuts. M. K. Morse has the right blade for cutting anything from hardwoods to metals to plastics. All are available in different shank configurations to fit various saw models.

	Bi-Metal Blades	Carbon Steel Blades	Carbide Grit Blades
Blade Type			
Application			
Bi-Metal	Used primarily for cutting ferrous and non-ferrous metals. Milled and set teeth allow for better clearance while cutting metal. Using a larger tooth (6, 8 tpi) allows for more efficient cutting in hard board, wood and other wood composites.		
Carbon Steel	Used for cutting all types of wood and non-metallic products. The conical ground/cross sharpened teeth offer very clean and fast cuts. Specs also available in milled and set style teeth.		
Carbide Grit	Used for cutting fiberglass, ceramic tile, composites, laminates, marble floor tiles, etc. Super resistance to heat, wear and abrasion. Allows the cutting of materials that other blades are unable to cut.		

BI-METAL BLADES

For cutting ferrous and non-ferrous metals. Hard, durable high speed steel tooth points electron beam welded to a spring steel backer for toughness and stability during cutting.



Recommended Use	Length X Width X Thickness		Teeth per Inch	25/Tube		5/Card 10/standard pack		2/Card 5/standard pack		Tooth Style
	Inches	mm		Prod #	Comp #	Prod #	Comp #	Prod #	Comp #	
UNIVERSAL SHANK: Used on all popular jig saw machines accepting universal shank.										
Wood, fiber board, asbestos, coarse-cut.	4 X 3/8 X .035	100 X 10 X .9	6	SB3606T25	400855	SB3606C5	404549	SB3606C2	397636	M
Wood, plywood, hard-board.	4 X 3/8 X .035	100 X 10 X .9	10	SB3610T25	400879	SB3610C5	404556	SB3610C2	397643	M
Non-ferrous metals, Fiberglass, hard rubber, nail-embedded wood.	4 X 3/8 X .035	100 X 10 X .9	14	SB3614T25	400893	SB3614C5	404563	SB3614C2	397650	M
Metal 18 gauge to 1/8".	3 X 3/8 X .035	75 X 10 X .9	18	SB2718T25	400794	SB2718C5	404518	SB2718C2	397612	M
Metal and non-ferrous metal up to 1/8".	3 X 3/8 X .035	75 X 10 X .9	24	SB2724T25	400831	SB2724C5	404525	SB2724C2	397629	M
Scroll - non-ferrous metals, fiberglass, plywood.	3-5/8 X 3/16 X .035	92 X 5 X .9	12	SB4125T25	399487	SB4125C5	404532	SB4125C2	397667	M
Scroll - metal 18 gauge to 1/8"	2-3/4 X 3/16 X .035	70 X 5 X .9	18	SB2718ST25	402972	SB2718SC5	404501	SB2718SC2	397605	M
T-SHANK: Used on all popular jig saw machines accepting Bosch or T-shank.										
Wood, fiber board, asbestos, roughing work.	4 X 5/16 X .040	100 X 8 X 1.0	6	SB0406T25	400732	SB0406C5	404600	SB0406C2	397704	M
General purpose - wood cutting, compositions, plastic.	4 X 5/16 X .035	100 X 8 X .9	8	SB0408T25	400756	SB0408C5	404617	SB0408C2	397711	M
All woods, composition material, plastics, plywood.	4 X 5/16 X .035	100 X 8 X .9	10	SB0410T25	400770	SB0410C5	404624	SB0410C2	397728	M
Steel and non-ferrous Metal 1/8" thick and up.	3 X 3/8 X .035	75 X 10 X .9	14	SB0314T25	400671	SB0314C5	404570	SB0314C2	397674	M
Metals over 18 gauge, tubing, conduit.	3 X 3/8 X .035	75 X 10 X .9	18	SB0318T25	400695	SB0318C5	404587	SB0318C2	397681	M
Thin metal, plastic fine cuts under 18 gauge	3 X 3/8 X .035	75 X 10 X .9	24	SB0324T25	400718	SB0324C5	404594	SB0324C2	397698	M
Softwood, aluminum, non-ferrous metal up to 3/8", sandwich material up to 3-3/4". Extra long blade.	5-1/4 X 5/16 X .042 5-1/4 X 5/16 X .042	132 X 8 X 1.1 132 X 8 X 1.1	12 21	SB0512LT25 SB0521LT25	401272 401319	SB0512LC5 SB0521LC5	404631 404648			M M



JIG SAW BLADE ASSORTMENTS

6-piece assortments offer lots of versatility; packaged in a vinyl pouch.

Product #	Computer #	Shank	One Each (6 Pieces/Pouch)	Pouch
UNIVERSAL SHANK: Used on all popular jig saw machines accepting universal shank.				
SB1P	401173	1/4" Universal Shank	SB3606, SB3610, SB3614, SB2718, SB2724, SB4125	Vinyl
SC1P	401418	1/4" Universal Shank	SC406, (2)SC410, SC410R, SC2720, SC4125	Vinyl
SBC01	402163	1/4" Universal Shank	SB2718, SB2724, SB3606, SB3610, SB3614	Carded
T-SHANK: Used on all popular jig saw machines accepting Bosch or T-shank.				
SB2P	401531	T-Shank	SB0406, SB0410, SB0314, (2)SB0318, SB0324	Vinyl
SC2P	401432	T-Shank	SC0406, (2)SC0410, SC0410R, SC0416S, SC0320S	Vinyl

CARBON BLADES

High quality carbon steel blades are ideal for cutting woods, chipboards, plywoods, plastics and similar materials. Tooth styles are either milled or cross sharpened-conical ground. Shank styles are available in either universal or T-shank.

PACKAGING: 5 per card, 10 per standard pack
2 per card, 5 per standard pack

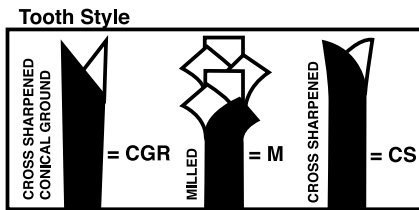

JIG SAW BLADES
Carbon Jig Saw Blades

Recommended Use	Length X Width X Thickness		Teeth per Inch	25/Tube		5/Card		2/Card		Tooth Style
	Inches	mm		Prod #	Comp #	Prod #	Comp #	Prod #	Comp #	
UNIVERSAL SHANK: Used on all popular jig saw machines accepting universal shank.										
Softwood, hardwood, plywood, chipboard, plastic up to 2" thick. Clean/fast cutting.	4 X 5/16 X .050	100 X 8 X 1.3	6	SC406T25	399722	SC406C5	404853	SC406C2	397865	CGR
Softwood, hardwood, plywood, chipboard, plastic up to 1" thick. Very clean cuts.	4 X 5/16 X .050	100 X 8 X 1.3	10	SC410T25	399746	SC410C5	404860	SC410C2	397889	CGR
Reverse tooth - non-splitting cuts of laminates, and chipboard. Very clean cutting.	4 X 5/16 X .060	100 X 8 X 1.5	10	SC410RT25	399739	SC410RC5	404877	SC410RC2	397872	CGR
Scroll cutting wood, plywood, plastics 1/4" to 1" thick. Smooth cuts.	3-5/8 X 5/16 X .035	92 X 8 X .9	12	SC412ST25	399760	SC412SC5	404822	SC412SC2	397896	M
Scroll cutting wood, plywood, plastics 1/4" to 1" thick. Smooth cuts.	2-3/4 X 1/4 X .035	70 X 6 X .9	12	SC2712T25	399678	SC2712C5	404808	SC2712C2	397827	M
Scroll cutting wood, plywoods, etc. Super fine finish. Ground, taper back.	2-3/4 X 3/16 X .050	70 X 5 X 1.3	20	SC2720T25	399692	SC2720C5	404815	SC2720C2	397834	CGR
T-SHANK: Used on all popular jig saw machines accepting Bosch or T-shank.										
Softwood, hardwood, plywood, chipboard. Fast coarse cutting.	4 X 5/16 X .050	100 X 8 X 1.3	6	SC046T25	401401	SC046C5	404914	SC046C2	397964	M
Softwood, hardwood, plywood, chipboard, plastic up to 2" thick. Clean/fast cutting.	4 X 5/16 X .060	100 X 8 X 1.5	6	SC0406T25	400329	SC0406C5	404921	SC0406C2	397926	CGR
Softwood, hardwood, plywood, chipboard, plastic up to 1" thick. Very clean cuts.	4 X 5/16 X .060	100 X 8 X 1.5	10	SC0410T25	400510	SC0410C5	404938	SC0410C2	397940	CGR
Reverse tooth - non-splitting cuts of laminates, and chipboard. Very clean cutting.	4 X 5/16 X .060	100 X 8 X 1.5	10	SC0410RT25	400503	SC0410RC5	404945	SC0410RC2	397933	CGR
Curved cuts/scroll in softwood and hardwood up to 1" thick. Fast cutting.	3 X 5/32 X .040	75 X 4 X 1	12	SC0312ST25	401142	SC0312SC5	404884	SC0312SC2	397902	M
Curved cuts/scroll in softwood and hardwood up to 1" thick. Fast cutting.	3 X 3/16 X .050	75 X 5 X 1.3	20	SC0320ST25	401364	SC0320SC5	404891	SC0320SC2	397919	CGR
Curved cuts/scroll in softwood and hardwood up to 2" thick. Fast cutting.	4 X 1/4 X .050	100 X 6 X 1.3	6	SC0416ST25	400534	SC0416SC5	404907	SC0416SC2	397957	CGR

TOOTH STYLE: M (Milled) CGR (Cross Sharpened, Conical Ground)



BAYONET SHANK JIG SAW BLADES

For cutting ferrous and non-ferrous metals. Hard, durable high speed steel tooth points electron beam welded to a spring steel backer for toughness and stability during cutting.

PACKAGING: 5 per card, 10 cards per standard pack

Recommended Use	Length X Width X Thickness		Teeth Per Inch	25/Tube		5/Card	
	Inches	mm		Product #	Computer #	Product #	Computer #
Wood, plastic, composites.	3 X 3/8 X .035	75 X 10 X .9	6	SBB306T25	400619	SBB306C5	404686
Wood, composites, non-ferrous metals, medium-smooth finish.	3 X 3/8 X .035	75 X 10 X .9	10	SBB310T25	400633	SBB310C5	404693
Steel and non-ferrous metals 1/8" thick and above - plastic, asbestos, fiberglass, hard rubber and fiber.	3 X 3/8 X .035	75 X 10 X .9	14	SBB314T25	400657	SBB314C5	404709
Metal over 1/8" thick, plastic, fiberglass.	1-3/4 X 1/4 X .035	45 X 6 X .9	14	SBB214T25	400558	SBB214C5	404655
Heavy gauge metal - 18 gauge to 1/8".	1-3/4 X 1/4 X .035	45 X 6 X .9	18	SBB218T25	400572	SBB218C5	404662
Metal - 18 gauge and under.	1-3/4 X 1/4 X .035	45 X 6 X .9	24	SBB224T25	400596	SBB224C5	404679

CARBIDE GRIT JIG SAW BLADES

For cutting materials too hard, abrasive or thin for bi-metal blades. Tungsten carbide grains are bonded to alloy body creating smooth cutting blades that won't tear thin materials and offer a long life when cutting difficult materials.

Cuts fiberglass, lath, plaster, ceramic tile, soil pipe, composites, particleboard, laminates, hardwood flooring, marble, hardened steel, and more.



UNIVERSAL SHANK

Description	25/Tube		1/Card - 5/Standard Pack	
	Product #	Computer#	Product #	Computer#
2-3/4" Fine Grit Saw	STCG27-FT25	402859	SCTCG27-F	402699
2-3/4" Medium Grit Saw	STCG27-MT25	402866	SCTCG27-M	402705
2-3/4" Coarse Grit Saw	STCG27-CT25	402873	SCTCG27-C	402712
3-5/8" Fine Grit Saw	STCG36-FT25	402880	SCTCG36-F	402729
3-5/8" Medium Grit Saw	STCG36-MT25	402897	SCTCG36-M	402736
3-5/8" Coarse Grit Saw	STCG36-CT25	402903	SCTCG36-C	402743







T-SHANK

Description	25/Tube		1/Card - 5/Standard Pack	
	Product #	Computer#	Product #	Computer#
4" Fine Grit Saw	SOTCG4-FT25	402828	SCOTCG4-F	402668
4" Medium Grit Saw	SOTCG4-MT25	402835	SCOTCG4-M	402675
4" Coarse Grit Saw	SOTCG4-CT25	402842	SCOTCG4-C	402682

PORTABLE BAND SAW BLADES

These rugged, heat treated blades are welded-to-length in our manufacturing plant. They install easily, last a long time and smoothly cut a wide variety of materials.

Master Cobalt® Bi-Metal	Standard Bi-Metal	Carbon Steel	Stationary Band Saw Blades
			
Blade Type	Application		
Master Cobalt® Bi-Metal	Use on machinable metals, including stainless steel, pipe, tubing and solids. Premium variable pitch blades offer high heat, wear and shock resistance. Variable pitch allows a broader range of applications and reduced vibration when cutting. This combination results in the longest blade life among competitive blades.		
Standard Bi-Metal	Use on machinable metals, including stainless steel, pipe, tubing and solids. Premium straight pitch blades offer high resistance to heat, wear and shock contributing to longer blade life.		
Carbon Steel	Use on easy to machine metals. These economical blades are straight pitch.		
Stationary Band Saw Blades	Use for cutting wood and easy to machine metals. Carbon hard edge/flex back blades offer reliable performance.		

MASTER COBALT®

Premium bi-metal blades feature Matrix II cutting edges and the longest life compared to any competitive blades. Variable pitch teeth reduce vibration. PACKAGING: 3 & 5 per box - 20 boxes per carton. BULK: 100 blades of specification per carton.

Length		TPI	Set	Boxed 3/box		Boxed 5/box		Bulk 100/carton	
Inches	mm			Product #	Comp. #	Product #	Comp. #	Product #	Comp. #
VARIABLE PITCH									
44-7/8 X 1/2 X .020	1140 X 12.7 X .50	10/14	Modified Raker	ZWEP441014MC	001175	ZWEP441014MCB5	002370	ZWEP441014MCB	002233
44-7/8 X 1/2 X .020	1140 X 12.7 X .50	14/18	Wavy	ZWEP441418MC	001182			ZWEP441418MCB	002240
44-7/8 X 1/2 X .020	1140 X 12.7 X .50	20/24	Wavy	ZWEP442024MC	001199	ZWEP442024MCB5	002363	ZWEP442024MCB	002257

STANDARD BI-METAL

With Matrix II cutting edges and straight pitch teeth, these blades cut fast and last a long time with reduced breakage.

PACKAGING: 3 per box, 20 boxes per carton (15 per carton for blades over 53"). BULK: 100 blades of spec per carton.

Length		TPI	Set	Boxed 3/box		Bulk 100/carton		1/Card - 5/Standard Pack	
Inches	mm			Product #	Computer #	Product #	Computer #	Product #	Computer #
STANDARD PITCH									
44-7/8 X 1/2 X .020	1140 X 12.7 X .50	10	Raker	ZWEP4410R	001205	ZWEP4410RB	002158	ZCWEAD10	000017
44-7/8 X 1/2 X .020	1140 X 12.7 X .50	14	Wavy	ZWEP4414W	001212	ZWEP4414WB	002165	ZCWEAD14	000024
44-7/8 X 1/2 X .020	1140 X 12.7 X .50	18	Wavy	ZWEP4418W	001229	ZWEP4418WB	002172	ZCWEAD18	000031
44-7/8 X 1/2 X .020	1140 X 12.7 X .50	24	Wavy	ZWEP4424W	001236	ZWEP4424WB	002189	ZCWEAD24	000048
53-3/4 X 1/2 X .020	1365 X 12.7 X .50	10	Raker	ZWEP5310R	001274	ZWEP5310RB	002196		
53-3/4 X 1/2 X .020	1365 X 12.7 X .50	14	Wavy	ZWEP5314W	001281	ZWEP5314WB	002202		
53-3/4 X 1/2 X .020	1365 X 12.7 X .50	18	Wavy	ZWEP5318W	001298	ZWEP5318WB	002219		
53-3/4 X 1/2 X .020	1365 X 12.7 X .50	24	Wavy	ZWEP5324W	001304	ZWEP5324WB	002226		
53-3/4 X 1/2 X .020	1365 X 12.7 X .50	10/14	Raker	ZWEP531014	001311	ZWEP531014B	002264		
53-3/4 X 1/2 X .020	1365 X 12.7 X .50	14/18	Wavy	ZWEP531418	001328				
54 X 1/2 X .025	1372 X 12.7 X 6.4	10	Raker	ZWEP5410R	001342	ZWEP5410RB	001588		
54 X 1/2 X .025	1372 X 12.7 X 6.4	14	Wavy	ZWEP5414W	001359	ZWEP5414WB	001595		
54 X 1/2 X .025	1372 X 12.7 X 6.4	18	Wavy	ZWEP5418W	001366	ZWEP5418WB	001601		
54 X 1/2 X .025	1372 X 12.7 X 6.4	24	Wavy	ZWEP5424W	001373	ZWEP5424WB	001618		

HEAVY DUTY .025 THICKNESS BLADES

Length		TPI	Set	Pitch	Boxed 3/box	
Inches	mm				Product #	Comp. #
44-7/8 X 1/2 X .025*	1140 X 12.7 X .63	10/14	Modified Raker	Variable	ZWEP44251014	001953
44-7/8 X 1/2 X .025*	1140 X 12.7 X .63	14/18	Modified Raker	Variable	ZWEP44251418	001960
44-7/8 X 1/2 X .025*	1140 X 12.7 X .63	14	Wavy	Standard	ZWEP442514W	001939
44-7/8 X 1/2 X .025*	1140 X 12.7 X .63	18	Wavy	Standard	ZWEP442518W	001946

NEW SIZES

The same premium bi-metal blades in shorter lengths to fit smaller portable band saw machines.

Available in standard bi-metal and Master Cobalt. PACKAGING: 3 per box - 20 boxes per carton.

Length		TPI	Set	Boxed 3/box		Bulk 100/carton	
Inches	mm			Product #	Comp #	Product #	Comp #
28-13/16 X 1/2 X .020	732 X 12.7 X .50	10/14	Modified Raker	ZWEP281014MC	001755	ZWEP281014MCB	001786
28-13/16 X 1/2 X .020	732 X 12.7 X .50	14/18	Modified Raker	ZWEP281418MC	001748	ZWEP281418MCB	001779
28-13/16 X 1/2 X .020	732 X 12.7 X .50	24	Wavy	ZWEP2824W	001762	ZWEP2824WB	001793
32-7/8 X 1/2 X .020	835 X 12.7 X .50	10	Raker	ZWEP3210R	001885	ZWEP3210RB	003254
32-7/8 X 1/2 X .020	835 X 12.7 X .50	14	Wavy	ZWEP3214W	001908	ZWEP3214WB	003261
32-7/8 X 1/2 X .020	835 X 12.7 X .50	18	Wavy	ZWEP3218W	001915	ZWEP3218WB	003278
32-7/8 X 1/2 X .020	835 X 12.7 X .50	24	Wavy	ZWEP3224W	001922	ZWEP3224WB	003285
32-7/8 X 1/2 X .020	835 X 12.7 X .50	10/14	Modified Raker	ZWEP321014MC	001861	ZWEP321014MCB	003292
32-7/8 X 1/2 X .020	835 X 12.7 X .50	14/18	Modified Raker	ZWEP321418MC	001892	ZWEP321418MCB	003308
32-7/8 X 1/2 X .020	835 X 12.7 X .50	20/24	Modified Raker	ZWEP322024MC	001878	ZWEP322024MCB	003315
35-3/8 X 1/2 X .020	899 X 12.7 X .50	10	Raker	ZWEP3510R	003001	ZWEP3510RB	003407
35-3/8 X 1/2 X .020	899 X 12.7 X .50	14	Wavy	ZWEP3514W	003018	ZWEP3514WB	003414
35-3/8 X 1/2 X .020	899 X 12.7 X .50	18	Wavy	ZWEP3518W	003025	ZWEP3518WB	003421
35-3/8 X 1/2 X .020	899 X 12.7 X .50	24	Wavy	ZWEP3524W	003032	ZWEP3524WB	003438
35-3/8 X 1/2 X .020	899 X 12.7 X .50	10/14	Modified Raker	ZWEP351014MC	003049	ZWEP351014MCB	003445
35-3/8 X 1/2 X .020	899 X 12.7 X .50	14/18	Modified Raker	ZWEP351418MC	003056	ZWEP351418MCB	003452
35-3/8 X 1/2 X .020	899 X 12.7 X .50	20/24	Modified Raker	ZWEP352024MC	003063	ZWEP352024MCB	003469

25 PACK PORTABLE BAND SAW BLADES

Our most popular sizes of bi-metal portable band saw blades in easy-to-store, 25 pack dispenser boxes.

Length		TPI	Set	Pitch	Product #	Computer #
Inches	mm					
44-7/8 X 1/2 X .020	1140 X 12.7 X .50	14	Wavy	Standard	ZWEP4414WB25	002318
44-7/8 X 1/2 X .020	1140 X 12.7 X .50	18	Wavy	Standard	ZWEP4418WB25	002301
44-7/8 X 1/2 X .025	1140 X 12.7 X .63	14	Wavy	Standard	ZWEP442514WB25	001977
44-7/8 X 1/2 X .025	1140 X 12.7 X .63	18	Wavy	Standard	ZWEP442518WB25	001984
44-7/8 X 1/2 X .020	1140 X 12.7 X .50	10/14	Wavy	Variable	ZWEP441014MCB25	002356
44-7/8 X 1/2 X .020	1140 X 12.7 X .50	14/18	Wavy	Variable	ZWEP441418MCB25	002295
44-7/8 X 1/2 X .025	1140 X 12.7 X .63	10/14	Modified Raker	Variable	ZWEP44251014B25	001991
44-7/8 X 1/2 X .025	1140 X 12.7 X .63	14/18	Modified Raker	Variable	ZWEP44251418B25	002004



CARBON BLADES

These economical blades are milled from solid carbon steel. Suitable for use on easier-to-machine metals, including pipe, tubing and solids.

PACKAGING: 3 blades per box, 20 boxes per carton (15/carton for blades over 53") BULK: 100 blades of spec. per carton.

Length		TPI	Set	Boxed		Bulk	
Inches	mm			Product #	Computer #	Product #	Computer #
STANDARD PITCH							
44-7/8 X 1/2 X .020	1140 X 12.7 X .50	6	Raker	ZHEP4406	001533	ZHEP4406B	001656
44-7/8 X 1/2 X .020	1140 X 12.7 X .50	10	Raker	ZHEP4410	001410	ZHEP4410B	001663
44-7/8 X 1/2 X .020	1140 X 12.7 X .50	14	Wavy	ZHEP4414W	001427	ZHEP4414WB	001670
44-7/8 X 1/2 X .020	1140 X 12.7 X .50	18	Wavy	ZHEP4418W	001434	ZHEP4418WB	001687
44-7/8 X 1/2 X .020	1140 X 12.7 X .50	24	Wavy	ZHEP4424W	001441	ZHEP4424WB	001694
53-3/4 X 1/2 X .020	1365 X 12.7 X .50	10	Raker	ZHEP5310	001458	ZHEP5310B	001700
53-3/4 X 1/2 X .020	1365 X 12.7 X .50	14	Wavy	ZHEP5314W	001465	ZHEP5314WB	001717
53-3/4 X 1/2 X .020	1365 X 12.7 X .50	18	Wavy	ZHEP5318W	001472	ZHEP5318WB	001724
53-3/4 X 1/2 X .020	1365 X 12.7 X .50	24	Wavy	ZHEP5324W	001489	ZHEP5324WB	001731
54 X 1/2 X .025	1372 X 12.7 X 6.4	10	Raker	ZHEP5410	001496	ZHEP5410B	001540
54 X 1/2 X .025	1372 X 12.7 X 6.4	14	Wavy	ZHEP5414W	001502	ZHEP5414WB	001557
54 X 1/2 X .025	1372 X 12.7 X 6.4	18	Wavy	ZHEP5418W	001519	ZHEP5418WB	001526
54 X 1/2 X .025	1372 X 12.7 X 6.4	24	Wavy	ZHEP5424W	001564	ZHEP5424WB	001571

STATIONARY BAND SAW BLADES

These blades are designed for use on stationary band saws. All are manufactured from carbon hard edge flexible back material with teeth hardened to Rc 64-66. They provide reliable cutting action on wood and metals with guaranteed welds.

PACKAGING: 1 blade per card.
5 cards per box.



Selection Guide - Carbon Hard Edge Flexible Back

Length X Width X Thickness		Teeth Per Inch															
		03		04		06		08		14		18		24		32	
Inches	mm	Prod #	Comp #	Prod #	Comp #	Prod #	Comp #	Prod #	Comp #	Prod #	Comp #	Prod #	Comp #	Prod #	Comp #	Prod #	Comp #
52-3/4 X 1/8 X .018	1340 X 3.2 X .5					ZCAB06	000178	ZCAA08A	002509	ZCAA14A	002516	ZCAB18	000192	ZCAB24	000208	ZCAB32	000215
52-3/4 X 1/4 X .014	1340 X 6.4 X .3							ZCBA08A	002523	ZCBA14A	002530						
56-1/8 X 1/8 X .018	1426 X 3.2 X .5					ZCBB06	000246			ZCBB14A	000253	ZCBB18	000260	ZCBB24	000277	ZCBB32	000284
56-1/8 X 1/4 X .014	1426 X 6.4 X .3					ZCCB06	000673										
56-1/8 X 3/8 X .014	1426 X 9.5 X .3							ZCCA08A	002547	ZCCA14A	002554	ZCCB18	000338	ZCCB24	000345		
57 X 1/8 X .018	1448 X 3.2 X .5					ZCCB06	000314			ZCCB14	000321						
57 X 1/4 X .014	1448 X 6.4 X .3					ZCCC06	000352			ZCCB14	000369			ZCCB24	000376		
57 X 3/8 X .014	1448 X 9.5 X .3									ZCCA14A	002561						
59-1/4 X 1/8 X .018	1505 X 3.2 X .5					ZCZB06	000819										
59-1/4 X 1/4 X .014	1505 X 6.4 X .3					ZCZC06	000826										
59-1/4 X 3/8 X .014	1505 X 9.5 X .3							ZCDA08A	002578	ZCDA14A	002585	ZCDB18	000420	ZCDB24	000437	ZCDB32	000444
59-1/2 X 1/8 X .018	1511 X 3.2 X .5					ZCDB06	000406			ZCDB14	000413			ZCDB24	000482	ZCDB32	000499
59-1/2 X 1/4 X .014	1511 X 6.4 X .3					ZCDC06	000451			ZCDB14	000468			ZCDC24			
59-1/2 X 3/8 X .014	1511 X 9.5 X .3							ZCEA08A	002592	ZCEA14A	002608	ZCEB18	000543	ZCEB24	000550	ZCEB32	000567
62 X 1/8 X .018	1575 X 3.2 X .5					ZCEB06	000529			ZCEB14	000536			ZCEC24	000604	ZCEC32	000611
62 X 1/4 X .014	1575 X 6.4 X .3					ZCEC06	000574			ZCEB14	000581			ZCFD24			
62 X 3/8 X .014	1575 X 9.5 X .3					ZCFD06	000628			ZCFD14	000635	ZCFD18	000642	ZCFD24	000659	ZCFD32	000666
64-1/2 X 1/2 X .025	1638 X 12.7 X .6									ZCGA14A	002615						
70 X 1/8 X .018	1778 X 3.2 X .5					ZCGB06	000697										
70 X 1/4 X .014	1778 X 6.4 X .3					ZCGC06	000703										
70 X 3/8 X .014	1778 X 9.5 X .3									ZCHA14A	002622						
71-3/4 X 1/8 X .018	1822 X 3.2 X .5					ZCHB06	000857										
71-3/4 X 1/4 X .014	1822 X 6.4 X .3									ZCIA14	000871						
71-3/4 X 3/8 X .014	1822 X 9.5 X .3																
72-7/16 X 1/8 X .025	1840 X 3.2 X .6																
72-7/16 X 1/4 X .025	1840 X 6.4 X .6			ZCIC04	001076	ZCIB06	000888										
72-7/16 X 3/8 X .025	1840 X 9.5 X .6	ZCID03	001083														
72-7/16 X 1/2 X .025	1840 X 12.7 X .6									ZCJA14A	002639						
80 X 1/8 X .018	2032 X 3.2 X .5					ZCJB06	000901										
80 X 1/4 X .014	2032 X 6.4 X .3					ZCJC06	000918										
80 X 3/8 X .014	2032 X 9.5 X .3									ZCKA14A	002646						
82 X 1/8 X .018	2083 X 3.2 X .5					ZCKB06	000949										
82 X 1/4 X .014	2083 X 6.4 X .3					ZCKC06	000956										
82 X 3/8 X .014	2083 X 9.5 X .3																
93-1/2 X 1/8 X .025	2362 X 3.2 X .6					ZCLA14	000970			ZCLA14	000970						
93-1/2 X 1/4 X .025	2362 X 6.4 X .6					ZCLB06	000987			ZCLB14	001052	ZCLC18	001007				
93-1/2 X 3/8 X .025	2362 X 9.5 X .6					ZCLC06	000994			ZCLC14	001069	ZCLD18	001038	ZCLD24	001045		
93-1/2 X 1/2 X .025	2362 X 12.7 X .6					ZCLD06	001014			ZCLD14	001021						

We manufacture a full line of high-quality, long-life industrial band saw blades. For a free copy of the Morse Industrial Band Saw Blade Catalog, call 1-800-733-3377.

CIRCULAR SAW BLADES Metal Devil®

Cut through
6" x 1/4" thick plate
steel in less than
12 seconds!

METAL DEVIL® METAL-CUTTING CIRCULAR SAW BLADES

Morse Metal Devil® Saw Blades cut through steel and other tough metals as easily as traditional circular saw blades cut through soft pine 2x4's. These devils cut faster, cut cooler and cut longer than anything you are used to seeing in industrial plants or construction sites alike. You have got to see it to believe it.

Cut Cool

When we demonstrate the Morse Metal Devil® blade, we ask viewers to touch the freshly cut metal edges. People are amazed to find how cool it is to the touch. The unique metallurgy of the carbide tips means there is minimal heat transferred to the inner plate.

Cut Faster

Morse Metal Devil® blades cut so much faster than traditional methods, that it is hardly even a race. Consider that a Morse Metal Devil® blade can cut through 6" x 1/4" thick steel in approximately 12 seconds.

Cut longer

The Morse Metal Devil® is constructed with a hardened steel inner plate that has a unique combination of tungsten carbide and titanium carbide tips brazed to the teeth. As a result Morse Metal Devil® blades offer exceptional wear resistance and make more cuts than any other metal cutting blade on the market today.

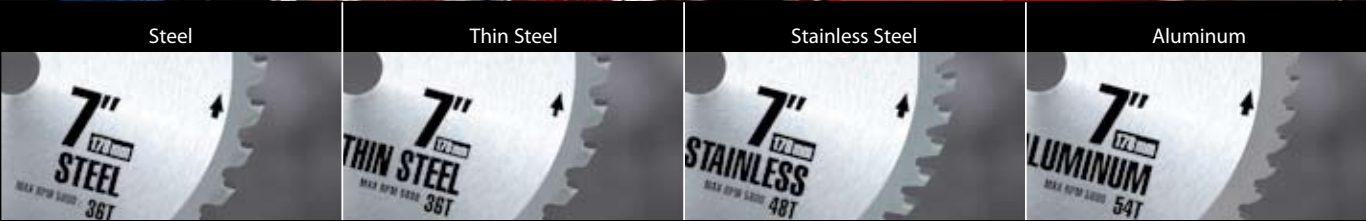

Blade Type	Application
Steel	Used to cut angle iron, steel plate, channel iron, I-beams, pipe and other ferrous metal shapes and parts.
Thin Steel	Used to cut ferrous metals under 1/8" without bending the cut edge including corrugated roofing, sheet metal, conduit, and steel studs.
Stainless Steel	Used to cut all stainless steel, including 1/4" or thinner stainless plate, or 1/8" or thinner wall stainless tube.
Aluminum	Used to cut all 3/8" or thinner aluminum parts including extrusions, plate, angle and grating.

Metal Devil **NXT**TM

We've combined metal cutting technology with science to develop a cutting performance that separates the all new Metal Devil NXTTM from the competition



**HIGH GRADE
CARBIDE**
+
**OPTIMIZED
TIP DESIGN**

**CONSISTENCY
RELIABILITY
LESS VIBRATION**

CIRCULAR SAW BLADES
Metal Devil NXTTM

NEW PLATE TECHNOLOGY

ADVANTAGE: Stability of plate through manufacturing processes

BENEFIT: Smoother cuts & longer blade life



NEW TIP DESIGN TAILORED TO THE CUTTING APPLICATION

ADVANTAGE: New technology minimizes stress in the carbide tips

BENEFIT: Longer blade life

NEW CARBIDE GRADES

ADVANTAGE: Longer and consistent blade life

BENEFIT: Lowest cost-per-cut and satisfied end users

STEEL CUTTING APPLICATIONS



STEEL
GRATING



STEEL PLATE
3/16" - 3/8" (4.8 - 9mm)
Thickness



ANGLE IRON
1/4" (6mm)
Max Thickness



C-CHANNEL
3" - 6"
(76 - 150mm)



STEEL PIPE
3/16" - 1/4" (4.8 - 6mm) Wall Thickness
BLACK PIPE
Up to 2" (51mm) Diameter

METAL DEVIL® & METAL DEVIL NXT™ BLADES

▼ Denotes Metal Devil NSC blade

Blade Diameter	Part Number	Number of Teeth	Arbor	Applications	Computer Number	MAX RPM	Machine
5 3/8" 137mm	CSM5383058SC	30	5/8	Steel	100717	4200	Makita BCS550 / BSS501
	CSM5383258NSC ▼	32	5/8	Steel	101332	4200	
	CSM53832NSC ▼	32	20mm	Steel	101325	4200	Milwaukee M18 Makita BCS550 / BSS501 Panasonic EY3530NQMKW / EY452LN2M
	CSM53850AC	50	20-10mm-5/8	Aluminum	100014	4200	
	CSM53850TSC	50	20-10mm-5/8	Thin Steel	100021	4200	
6 1/4" 159mm	CSM62560AC	60	5/8	Aluminum	100052	4200	Makita 5046DWDE
	CSM62548SIC	48	20-16mm	Steel	100434	4200	Standard Circular Saws
	CSM62556TSIC	56	20-16mm	Thin Steel	100441	4200	
6 1/2" 165mm	CSM65040SC	40	5/8	Steel	100069	4200	Bosch CCS180K / 1617K Makita BSS610 Dewalt DC310K / DC390K Ridgid R3203 Milwaukee 2630-20 / 0730-20
	CSM65048TSC	48	5/8	Thin Steel	100076	4200	
	CSM65060AC	60	5/8	Aluminum	100083	4200	
	CSM6504020NSC ▼	40	20mm	Steel	101523	4200	Panasonic EY3552GQW
	CSM6504820TSC	48	20mm	Thin Steel	100649	4200	
6 3/4" 171mm	CSM67540NSC ▼	40	20mm	Steel	101530	4200	Dewalt DW934K-2
	CSM6754030SIC	40	30mm	Steel	100458	4200	
	CSM6754830TSIC	48	30mm	Thin Steel	100472	4200	Standard Circular Saws
7" 178mm	CSM740NSC ▼	40	20mm	Steel	101363	5800	Morse CSM7MB Evolution Steel Saw Jancy MCSL07-2 Milwaukee 0740-20
	CSM748SSC	48	20mm	Stainless Steel	100144	5800	
	CSM754AC	54	20mm	Aluminum	100151	5800	
	CSM768TSC	68	20mm	Thin Steel	100168	5800	
	CSM768TSIC	68	30-20mm	Thin Steel	100496	5800	
7 1/4" 184mm	CSM72540NSC ▼	40	5/8 KO*	Steel	101349	5800	Bosch CSS / CS10 / CS20 / 1677M / 1677MD Dewalt DC300K / 364 / DW368 DW369CSK Makita 4131 / 5057KB / 5007FAK / 5007FK / 5740NB / 5377MG / 5277NB Milwaukee 6390-20 / 6391-21 / 6394-21 / 6477-20
	CSM72548NSC ▼	48	5/8 KO*	Steel	101356	5800	
	CSM72560AC	60	5/8 KO*	Aluminum	100199	5800	
	CSM72568TSC	68	5/8 KO*	Thin Steel	100397	5800	
	CSM7254020SC	40	20mm	Steel	100656	5800	
	CSM72550SIC	50	20-16mm	Steel	100519	5800	
	CSM7256020AC	60	20mm	Aluminum	100663	5800	
	CSM72568TSIC	68	20-16mm	Thin Steel	100526	5800	
7 1/2" 191mm	CSM75060AC	60	20mm	Aluminum	100229	5800	Standard Circular Saws
	CSM75068TSC	68	20mm	Thin Steel	100236	5800	
	CSM7505030SIC	50	30mm	Steel	100557	5800	
	CSM7506830TSIC	68	30mm	Steel	100533	5800	
8" 203mm	CSM842NSC ▼	42	5/8	Steel	101387	5800	Milwaukee 6370-20
	CSM848NSC ▼	48	5/8	Steel	101394	5800	
	CSM860AC	60	5/8	Aluminum	100267	5800	
	CSM868TSC	68	5/8	Thin Steel	100274	5800	
	CSM868TSIC	68	30mm	Thin Steel	100571	5800	
8 1/4" 210mm	CSM82548NSC ▼	48	5/8 KO*	Steel	101370	5800	Dewalt DW384, Makita 5008MGA
	CSM82550SC	50	5/8 KO*	Steel	100281	5800	
9" 229mm	CSM948NSC ▼	48	1	Steel	101400	3200	Morse CSM9MB Evolution Steel Saw 5 Jancy MCSL09 / MCSL09-2
	CSM960SSC	60	1	Stainless Steel	100403	3200	
	CSM968TSC	68	1	Thin Steel	100311	3200	
	CSM980AC	80	1	Aluminum	100328	3200	
	CSM948SIC	48	30-20mm	Steel	100595	3200	
CSM968TSIC	68	30-20mm	Thin Steel	100601	3200	Standard Circular Saws	
10" 254mm	CSM1052TSC ▼	52	5/8	Thin Steel	100410	5200	Bosch 4410 / 4405, Dewalt DW713 Ridgid MS1065LZA
	CSM1080AC	80	5/8	Aluminum	100427	5500	
12" 305mm	CSM1260NSC	60	1	Steel	101561	1800	Makita LC1230
	CSM1280AC	80	1	Aluminum	100359	3800	
	CSM1280TSC	80	1	Thin Steel	100342	2000	
14" 356mm	CSM1466SC ▼	66	1	Steel	101318	1800	Morse CSM14MB, Dewalt DW872, Evolution Fury2 / Rage2 Evolution Steel Saw2 Jancy MCCS14 MCCS14-2 Milwaukee 6190-20 Ridgid 614
	CSM1480AC	80	1	Aluminum	100373	3800	
	CSM1481STC	81	1	Steel Studs	100670	1800	
	CSM1490TSC	90	1	Thin Steel	100380	1800	
	CSM1490SSC	90	1	Stainless Steel	100694	1800	
	CSM1472SIC	72	30mm	Steel	100618	1800	

5-3/8" blades include special bushings allowing them to fit 20mm, 10mm and 5/8" arbor holes
* 5/8 KO fits both diamond and circular arbors.

Computer Number: 101158

SPECIFICATIONS:

1080 Watts / 120 V / 60 Hz / 9 Amp
 No-Load Speed 3500 RPM
 Blade Diameter 7" (178mm)
 Arbor Hole 20mm
 Weight 13 Lbs.

CUTTING CAPABILITIES:

Maximum Cutting Reach 2.36"
 Maximum Thickness Cut (mild steel) 1/4"

STANDARD EQUIPMENT INCLUDES:

Carrying Case, Overload Switch, Retracting Blade Guard, Quick Release Metal Chip Collecting Cover, Length Adjuster, Side Handle, 6mm Hex Key, Safety Goggles, Ear Plugs, Morse Metal Devil® Steel Cutting Blade

ISO9002, CSA Safety Certified

7" CSM7MB

FEATURES:

EXTERNAL OVERLOAD SWITCH
 CHIP COLLECTION CHAMBER
 RETRACTABLE BLADE GUARD
 DURABLE CARRYING CASE



Computer Number: 101165

SPECIFICATIONS:

1800 Watts / 120 V / 60 Hz / 15 Amp
 No-Load Speed 2500 RPM
 Blade Diameter 9" (229mm)
 Arbor Hole 1"
 Weight 19.75 Lbs.

CUTTING CAPABILITIES:

Maximum Cutting Reach 3-1/4"
 Maximum Thickness of Cut (Mild Steel) 3/8"
 Bevel Cut 0-45°

STANDARD EQUIPMENT INCLUDES:

Carrying Case, Laser Guide, Side Handle, Length Adjuster, Overload Switch, Retracting Blade Guard, Quick Release Metal Chip Collection Cover, 1 Wrench Attached to Unit, Safety Goggles, Ear Plugs, Morse Metal Devil® Steel Cutting Blade

ISO9002, CSA Safety Certified

9" CSM9MB

FEATURES:

LASER GUIDE
 0°- 45° BEVELING
 30min. DUTY CYCLE
 OVERLOAD SWITCH
 CHIP COLLECTION CHAMBER
 RETRACTABLE BLADE GUARD
 DURABLE CARRYING CASE



Computer Number: 101172

SPECIFICATIONS:

120V / 60Hz / 15Amp
 No-Load Speed 1300 RPM
 Blade Diameter 14" (356mm)
 Arbor Hole 1"
 Weight 53 Lbs.

CUTTING CAPABILITIES:

	45°	90°
Round	4-1/8"	5-1/8"
Square	3-1/2" x 3-1/2"	4-3/4" x 4-3/4"
Rectangle	3-1/8" x 4-3/8"	3-3/4" x 7-1/4"

1/4" (.6mm) maximum wall thickness, mild steel tubing
 3/8" (.9mm) maximum thickness of cut mild steel

STANDARD EQUIPMENT INCLUDES:

Safety Guard, Mitering Vice, 8mm Hex Wrench, 6mm Hex Wrench, Safety Goggles, Ear Plugs, Morse Metal Devil® Steel Cutting Blade MC, ISO9002, CSA Safety Certified

14" CSM14MB

FEATURES:

0°- 45° MITERING VISE
 PLEXIGLASS SAFETY SHIELD
 CHIP COLLECTION CHAMBER
 RETRACTABLE BLADE GUARD





For the CSM14MB Saw

METAL DEVIL V-BLOCKS

- Durable Steel Body
- Securely Holds Rounds, Squares & Rectangular Materials
- Can Employ Several Vice Configurations to Accommodate a Variety of Structural Materials
- Strengthen The Clamping Performance of the Vice System
- Improves Cutting Performance on Structural Shapes
- Optimizes Blade Life
- Provides Precise Cutting Results
- Reduces Opportunity for Machine Damage



METAL DEVIL V-BLOCKS:
CSP14A01 / 100724

Maximum Material Dimensions to be used with V-Blocks:

- Square Material 3-7/8" Width
- Round Material 3" Diameter



ABRASIVE WHEEL MANDRELS

These mandrels are made to fit Type 1 resin bonded wheels that are a popular choice for high speed air or electric die grinders for both cut-off and grinding applications. You'll find them anywhere, from small fabrication shops, to giant automotive and aircraft assembly plants. Our abrasive wheel mandrels are precision machined to ensure concentricity for faster cutting and safer operation.



Product #	Computer #	Shank Size	Arbor Hole Size	Fits Wheel Thickness
Flush Type				
HMANF15	690089	1/4	3/8	1/32-1/4
HMANF250-S	690102	1/4	1/4	1/32-1/4
HMANF250-L	690096	1/4	1/4	1/4-1/2
HMANF375-S	690126	3/8	3/8	1/32-1/4
HMANF375-L	690119	3/8	3/8	1/4-1/2
HMAN40 Kit	690164	1/4,3/8	1/4-3/8	1/32-1/4
HMANC40 Kit	690010	1/4,3/8	1/4,3/8	1/32-1/4
Nut Type				
HMAN15	690133	1/4	3/8	1/32-1/4
HMAN250	690140	1/4	1/4	1/32-3/8
HMAN375	690157	3/8	3/8	1/32-1/2

Two styles:

Nut Type



for general purpose cutting, slotting or grinding applications.

Flush Type



for special access applications such as flush cuts or corner cuts.



HACK SAW BLADES AND FRAMES

The M. K. Morse Company began with three people packaging hack saw blades in an old laundry building. Years later Morse makes these blades in one of the most state-of-art saw blade manufacturing facilities in the world. But some things never change ... like the M. K. Morse commitment to quality and on-time delivery.

Morse hack saw blades and frames cover all possible job needs.

Bi-Metal	Triple Tooth™ Bi-Metal	Carbide Grit Rod	Carbide Grit
			
<p>Bi-Metal</p>	<p>Used to cut pipe, tubing, solids, wood, plastic or any machinable metal. Increased heat and wear resistance for long life. Flexible to prevent shattering during use.</p>		
<p>Carbide Grit</p>	<p>Used to cut glass, hardened steel, stranded cable and tile. Super resistance to heat wear and abrasion to allow the cutting of materials that other blades are unable to cut.</p>		

BI-METAL HACK SAW BLADES

Provide longest life when cutting tougher materials. High speed steel cutting edges are hardened to Rc 65-67 to resist heat and wear. Flexible backers resist shattering, resulting in safer, longer lasting blades. Vacuum heat treating creates harder edge for faster, easier cutting.

TRIPLE TOOTH™ BI-METAL HACK SAW BLADE

Utilize maximum cutting efficiency with three teeth sizes. Lead off with 32tpi, move to 24tpi for more aggressive strokes and complete the stroke with 18tpi. Or isolate the blade to use only one section.

Cut wood, plastic or any machinable metal, including conduit, stainless steel tubing, angle iron, copper tubing, structural materials and more.



Length X Width X Thickness		Teeth Per Inch	100/Tube		10/Tube		2/Card 5/Standard Pack	
Inches	mm		Product#	Comp #	Product#	Comp #	Product#	Comp #
12 X 1/2 X .025	300 X 12.7 X .6	18/24/32	HHB12182432T100	302340	HHB12182432T10	302333	HHCB12182432-2	304092

STANDARD BI-METAL HACK SAW BLADE

Cut wood, plastic or any machinable metal, including conduit, stainless steel tubing, angle iron, copper tubing, structural materials and more.



Length X Width X Thickness		Teeth Per Inch	100/Box		100/Tube		10/Tube		2/Card 5/Standard Pack	
Inches	mm		Product #	Comp #	Product#	Comp #	Product #	Comp #	Product #	Comp #
10 X 1/2 X .025	250 X 12.7 X .6	18	HHB1018	360180			HHB1018T10	300186	HHCB1018-2	304009
10 X 1/2 X .025	250 X 12.7 X .6	24	HHB1024	360241			HHB1024T10	300247	HHCB1024-2	304016
10 X 1/2 X .025	250 X 12.7 X .6	32	HHB1032	360326			HHB1032T10	300322	HHCB1032-2	304023
12 X 1/2 X .025	300 X 12.7 X .6	14	HHB1214	362146	HHB1214T100	300100	HHB1214T10	302142	HHCB1214-2	304030
12 X 1/2 X .025	300 X 12.7 X .6	18	HHB1218	362184	HHB1218T100	300117	HHB1218T10	302180	HHCB1218-2	304047
12 X 1/2 X .025	300 X 12.7 X .6	24	HHB1224	362245	HHB1224T100	300124	HHB1224T10	302241	HHCB1224-2	304054
12 X 1/2 X .025	300 X 12.7 X .6	32	HHB1232	362320	HHB1232T100	300131	HHB1232T10	302326	HHCB1232-2	304108
Variable Pitch										
12 X 1/2 X .025	300 X 12.7 X .6	14/18	HHB121418	362153	HHB121418T100	300148	HHB121418T10	302159	HHCB121418-2	304061
12 X 1/2 X .025	300 X 12.7 X .6	20/24	HHB122024	362160	HHB122024T100	300155	HHB122024T10	302166	HHCB122024-2	304078
12 X 1/2 X .025	300 X 12.7 X .6	26/32	HHB122632	362177	HHB122632T100	300162	HHB122632T10	302173	HHCB122632-2	304085

CARBIDE GRIT ROD SAWS AND HACK SAW BLADES

These specialty blades fit standard hack saw frames and cut hard materials like glass, ceramic tile, hardened steel, and more. The carbide grit cutting edges are super resistant to heat, wear and abrasion. They also resist snagging.



CARBIDE GRIT ROD SAWS

The thin cutting profile makes it easy to cut shapes and patterns even in limited access areas. Will not tear thin materials. Carbide grit is permanently bonded to a steel alloy rod. Cuts in both directions.

Dimensions		25/Box		3/Tube		1/Card - 5/Box	
Inches	mm	Product #	Computer #	Product #	Computer #	Product #	Computer #
10	250	HRTCG10	362214	HRTCG10T03	362351	HRCTCG10	332217
12	300	HRTCG12	362221	HRTCG12T03	362368	HRCTCG12	332224

CARBIDE GRIT HACK SAW BLADES

Cut difficult materials including hydraulic hose and stranded cable. Blades cut on both the push and pull stroke for faster cutting and longer life.



Dimensions		25/Box		3/Tube		1/Card - 5/Box	
Inches	mm	Product #	Computer #	Product #	Computer #	Product #	Computer #
10	250	HHCTCG10	362191	HHCTCG10T03	362337	HHCTCG10	332194
12	300	HHCTCG12	362207	HHCTCG12T03	362344	HHCTCG12	332200

MINI HACK SAW FRAME

This lightweight plastic frame is ideal for cutting in small, hard to reach areas. It is durable, comfortable to use and comes complete with a 10" bi-metal blade.

PACKAGING: 5 saws per box.



Description	Product #	Computer #
Mini hand hack saw frame with 10" bi-metal blade	HHBF05-10	330077

HACK SAW FRAMES

MASTER McCOY®

Another Morse original and the finest high performance hack saw frame you can find. It is stronger, cuts straighter, helps blades last longer and is more comfortable to use than other frames. It also offers more versatility and can make either standard or flush cuts.

PACKAGING: 1 frame per sleeve.
4 frames per box.
PRODUCT NO. **HHBFO2 / 330022**
Includes (1) 12" 20/24 TPI Blade

Locking Screw Design allows for storage of extra blades and secures blade for "jab" sawing

Alloy Steel Support Beam makes frame stronger and allows over 30,000 PSI tensioning.

Ergonomic grip protects fingers and grips comfortably

Multiple Pin Locations for mounting blade at 90° or 45° for standard or flush-cut applications

Tensioning Handle provides extra torque to keep blades rigid for straighter cuts and longer blade life.



LIGHTWEIGHT HIGH TENSION FRAME

Made from lightweight aluminum, it cuts straight whether making standard or flush cuts.

PACKAGING: 1 frame per sleeve.
4 frames per box.

PRODUCT NO. **HHBFO1 / 330015**
Includes (1) 12" 24 TPI Blade

Multiple Pin Locations for mounting blade at 90° or 45° for standard or flush-cut applications

Locking Screw Design allows for storage of extra blades and secures blade for "jab" sawing

Tensioning Handle provides extra torque for straighter cuts and longer blade life



From the deluxe lightweight Contractor High Tension Frame, to the ergonomically designed Contractor HD and the ever versatile Contractor Utility, Morse offers a hack saw frame for your contracting needs. Includes (1) 12" 24 TPI bimetel hack saw blade.

PACKAGING: 1 frame per sleeve. 4 frames per box.

Contractor High Tension
PRODUCT NO. **HHBFO4 / 300056**

Contractor HD
PRODUCT NO. **HHBFO3 / 300070**

Contractor Utility
PRODUCT NO. **HHBFO6 / 300063**

Exceptionally light for handling ease

Aluminum frame offers extra blade storage space

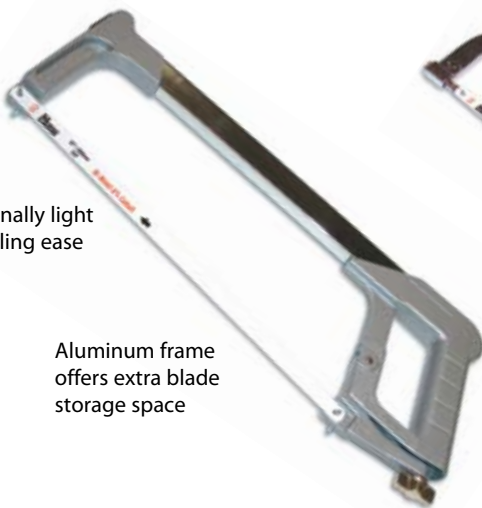

Excellent choice for tight spaces

Rubber handle for strong, comfortable grip



Precise blade tension with wing nut blade attachment

Adjusts for either 10" or 12" blade sizes



PVC/ABS SAW & REPLACEMENT BLADES

A handy saw for plumbers, electricians and DIY. These saws are light and comfortable with a replaceable spring-tempered steel blade. Available with 12" or 18" blades.

- Spring-tempered Carbon Steel Blade
- Tooth Hardness 65Rc
- Precision-milled Teeth
- Cuts on the Pull Stroke
- Comfort-grip Cast Aluminum Handle
- Single Screw Attachment



Description		
12" (305mm) Carbon Steel PVC/ABS Saw	HPVC1201	330107
18" (450mm) Carbon Steel PVC/ABS Saw	HPVC1801	330114
12" (305mm) Carbon Steel Replacement Blade	HPVCB12	330121
18" (450mm) Carbon Steel Replacement Blade	HPVCB18	330138



POWER HACK SAW BLADES

Bi-metal blades for use on modern high production power hack saw machines.

PACKAGING: 10 blades per box.

Length X Width X Thickness		Product #	Computer #	Teeth Per Inch
Inches	mm			
12 X 5/8 X .050	300 X 15.8 X 1.3	PHW125814	370011	14
		PHW125818	370028	18
12 X 1 X .050	300 X 25.4 X 1.3	PHW1205010	370035	10
		PHW1205014	370042	14
14 X 1 X .050	350 X 25.4 X 1.3	PHW1405010	370059	10
		PHW1405014	370066	14
14 X 1-1/4 X .062	350 X 32 X 1.6	PHW1406206	370073	6
		PHW1406210	370080	10
14 X 1-1/2 X .075	350 X 38 X 1.9	PHW1407504	370103	4
		PHW1407506	370110	6
17 X 1 X .050	425 X 25.4 X 1.3	PHW1705010	370127	10
		PHW1705014	370134	14
17 X 1-1/4 X .062	425 X 32 X 1.6	PHW1706206	370141	6
		PHW1706210	370158	10
18 X 1-1/4 X .062	450 X 32 X 1.6	PHW1806206	370165	6
		PHW1806210	370172	10
18 X 1-1/2 X .075	450 X 38 X 1.9	PHW1807504	370196	4
		PHW1807506	370202	6
18 X 1-3/4 X .088	450 X 45 X 2.2	PHW1808804	370226	4
		PHW1808806	370271	6
21 X 1-3/4 X .098	525 X 45 X 2.5	PHW2108804	370240	4
		PHW2108806	370257	6
24 X 2 X .100	600 X 50 X 2.5	PHW2410004	370264	4



PREMIUM SAWING SOLUTIONS

PORTABLE BAND SAW BLADES ▼ RECIPROCATING SAW BLADES ▼ JAB SAWS
HOLE SAWS & ACCESSORIES ▼ STEP DRILLS ▼ DOUBLE CUT AUGERS ▼ SPADE BITS
HACKSAW FRAMES & BLADES ▼ JIGSAW BLADES ▼ CIRCULAR SAWS & BLADES

Warranty

The M. K. Morse Company warrants each new product manufactured and sold by it or one of its authorized distributors only against defects in workmanship and/or materials under normal service, proper installation and use. THIS WARRANTY IS LIMITED TO REPAIR OR REPLACEMENT OF VERIFIED DEFECTIVE PRODUCTS AND EXCLUDES ANY AND ALL IMPLIED WARRANTY OF MERCHANTABILITY AND ALL RISK AND LIABILITY WHATSOEVER RESULTING FROM ANY USE OF SAID PRODUCTS, INCLUDING INCIDENTAL AND CONSEQUENTIAL DAMAGES. THERE ARE NO WARRANTIES WHICH EXTEND BEYOND THE DESCRIPTION ON THE FACE THEREOF. The provisions of this warranty and limitation of liability shall not be modified in any respect except by written document signed by an officer of The M. K. Morse Company.

Important

CUTTING TOOLS CAN SHATTER AND/OR BREAK UNDER IMPROPER OR SEVERE USE. WEAR SAFETY EQUIPMENT, AND PARTICULARLY EYE AND HEARING PROTECTION, AT ALL TIMES IN THE VICINITY OF THEIR USE. ALWAYS FOLLOW POWER TOOL MANUFACTURER'S RECOMMENDATIONS.



PHONE (330) 453-8187
FAX (330) 453-1111
HOTLINE (800) 733-3377
FAX HOTLINE (800) 729-1112

WEBSITES
mkmorse.com
bladewizard.com
independenceband.com

MAILING ADDRESS:
P.O. Box 8677
Canton, Ohio 44711 USA

SHIPPING ADDRESS:
1101 - 11th St., S.E.
Canton, Ohio 44707 USA